

NEED HELP?



SCAN OR CLICK HERE
TO CONTACT US



Air-Met Scientific
www.airmet.com.au

geotech

ETL Water Level Meter

Installation and Operation Manual



Table of Contents

DOCUMENTATION CONVENTIONS.....	2
Section 1: System Description	4
Section 2: System Installation	7
Section 3: System Operation	9
Section 4: System Maintenance	10
Section 5: System Troubleshooting.....	11
Section 6: System Specifications.....	12
Section 7: System Schematic	14
Section 8: Replacement Parts List	16
EC Declaration of Conformity	Error! Bookmark not defined.
The Warranty	21

DOCUMENTATION CONVENTIONS

This uses the following conventions to present information:



WARNING

An exclamation point icon indicates a **WARNING** of a situation or condition that could lead to personal injury or death. You should not proceed until you read and thoroughly understand the **WARNING** message.



CAUTION

A raised hand icon indicates **CAUTION** information that relates to a situation or condition that could lead to equipment malfunction or damage. You should not proceed until you read and thoroughly understand the **CAUTION** message.



NOTE

A note icon indicates **NOTE** information. Notes provide additional or supplementary information about an activity or concept.

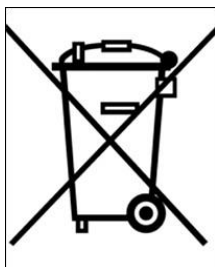

Notice for consumers in Europe:

This symbol indicates that this product is to be collected separately.

The following applies only to users in European countries:

- This product is designated for separate collection at an appropriate collection point. Do not dispose of as household waste.
- For more information, contact the seller or the local authorities in charge of waste management.

Section 1: System Description

Function and Theory

The Geotech ETL Water Level Meter (ETL WLM) is a portable instrument used to accurately measure water levels in monitoring wells and bore holes. The sensor consists of a stainless steel probe attached to a reel-mounted, polyethylene-coated engineer's tape. The engineer's tape comes in standard or metric graduations, and is accurate to 1/100th of a foot, or 1 millimeter.

The sensor relies on fluid conductivity to determine the presence of water. An audible signal and visible red LED activate when the probe contacts water. It features adjustable sensitivity, used to prevent false triggering.

The ETL WLM is intended for use as a depth to water measuring device. Using the ETL WLM for any other purpose may compromise safety of the operator and/or void manufacturer's warranty.



To avoid damage to tape and strain relief, do not over tighten reel with probe in storage position.

System Components



Figure 1-1: System Components

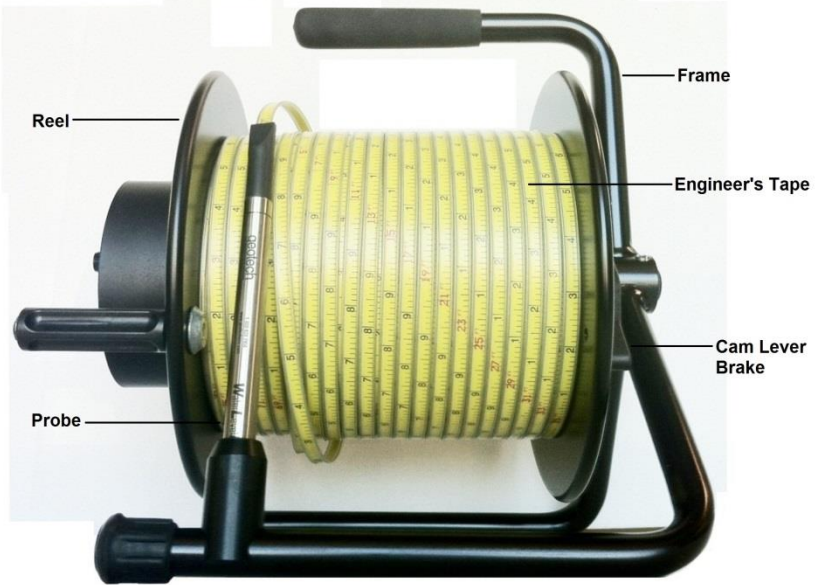

Figure 1-2: Reel Assembly



Figure 1-3: Reel Faceplate

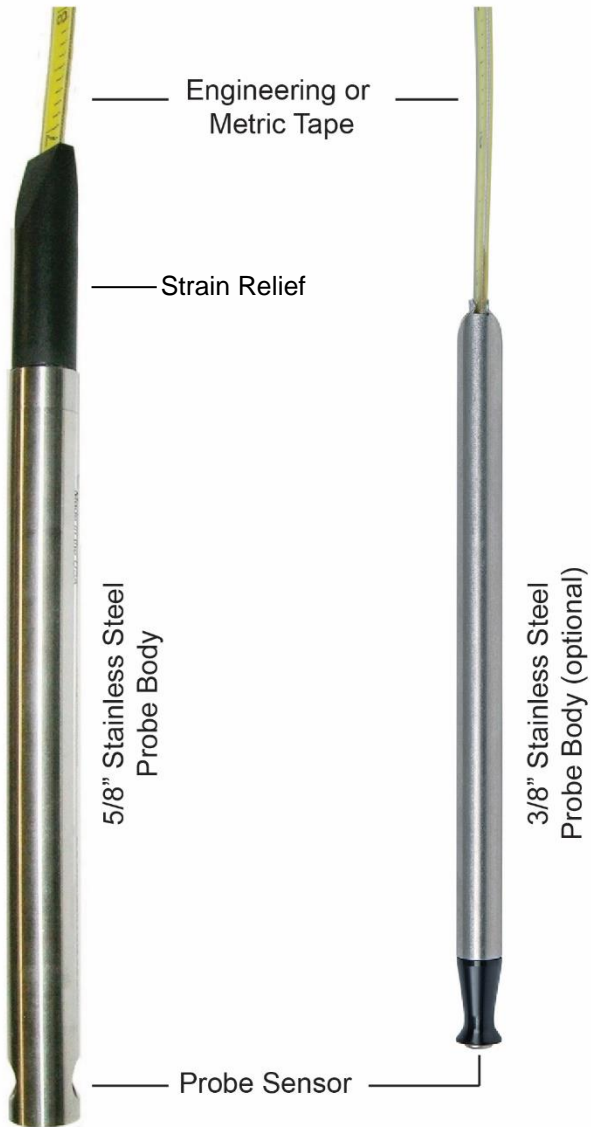

Figure 1-4: 5/8" Probe and 3/8" Probe

Section 2: System Installation

Place the reel next to the well casing and carefully lower the probe into the well using the tape leader guard to prevent damage to the tape.



Do not use the tape leader guard in wells larger than 4" (10cm), as it may fall down the well. The optional tape weight helps sink probe into a deep or crooked well

An optional Tape Guide, to prevent the edge of the well casing from damaging the tape, is also available from Geotech. Figure 2-1 is an example of the two parts.

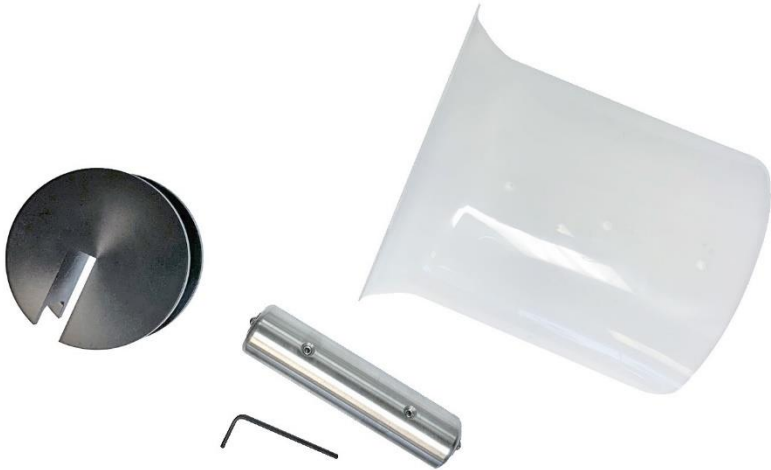

Figure 2-1: Tape Guide (optional), Tape Weight (optional), Tape Leader Guard

Optional Tape Weight Installation

Attach tape weight to tape near probe end being lowered into well.

- 1) Loosen the screws using an Allen wrench.
- 2) Slide the weight onto the tape (Figure 2-2).
- 3) Tighten the screws (Figure 2-3).



Figure 2-2: Fitting (Optional) Tape Weight



Figure 2-3: Tightening (Optional) Tape Weight

Section 3: System Operation

Turn the ETL WLM on with the ON/SENSITIVITY switch. If the buzzer makes a loud signal and a red light is visible, the battery is adequate for normal operation.

Lower the probe down the well to the water surface. The light and buzzer will activate. At this point, adjust the probe dial by rotating it counter-clockwise until the light and buzzer turn off.

With the probe still in contact with the water, adjust the probe sensitivity dial clockwise until the light and buzzer barely activate. In this setting, the probe will detect the water level and avoid false triggering.

Water level measurements can now be taken from the top of the casing or any reference point.

The ETL WLM should be stored with the ON/SENSITIVITY switch in the OFF position. To turn the unit off, rotate the switch fully counter-clockwise until the switch clicks. If the ETL WLM is not used and is stored for longer than three (3) months, remove the battery to prevent battery leakage, which can cause internal damage.



To avoid damage to the tape and strain relief, do not over tighten the reel with the probe in storage position.



This unit is not rated for use with hydrocarbons or flammable liquids. If measuring depth to fluid of wells containing hydrocarbons, use Geotech's line of interface probe products.

Section 4: System Maintenance

Battery Replacement

Replace the battery when the audible and visible signals become weak or the unit does not operate.

1. Gently remove the battery tray.
2. Remove the old battery and replace it with a new one.



Be aware of the polarity (+, -) of the battery when placing the new battery in the tray. Use a 9V alkaline battery only.

Cleaning

The ETL WLM can be cleaned with mild detergents such as trisodium phosphate (TSP). If other detergents are used, take care to select detergents that are compatible with Buna-N, polypropylene, and stainless steel. The reel should not be submerged in any liquid, but may be cleaned with a damp cloth.

Cleaning the Conductivity Contact

The conductivity contact of the probe should be periodically cleaned with a non-abrasive cleaner such as isopropyl alcohol, xylene, methanol, or phosphate free type cleaner. To clean the conductivity contact, place a small amount of the cleaner on a cotton swab; rub the conductivity contact to remove all foreign matter. Repeat this process until all foreign matter has been removed.

Section 5: System Troubleshooting

Problem: No signal (audible or visible) when unit is turned on.

Solutions:

- The battery is discharged. Check or change battery (*Section 4: System Maintenance*).
- The circuit is malfunctioning. Contact Geotech Service.

Problem: No indication of water.

Solutions:

- The conductive contact is dirty. Clean the contact (*Section 4: System Maintenance*).
- There is an open connection in the tape. Replace tape and/or probe.
- The circuit is malfunctioning. Contact Geotech Service.

Problem: The signal (audible or visible) is intermittent.

Solutions:

- There is an open connection in the tape. Replace tape and/or probe.
- There is a loose connection in the circuit or the probe. Repair the connection.

Problem: The signal (audible or visible) is continuous when not in water.

Solutions:

- The conductive contact is dirty (causing bridging). Clean the contact (*Section 4: System Maintenance*).
- There is a short in the tape and/or probe. Replace tape and/or probe.
- The circuit is malfunctioning. Contact Geotech Service.

For technical assistance, call Geotech Environmental Equipment at 1-303-320-4764 or 1-800-833-7958

Section 6: System Specifications

Geotech has taken steps to remove all polyflouroalkyl substances (PFAS) materials from ETL Water Level Meters.

Length/Weight: 500' (152 m) = 20 lbs (9 kg)
 750' (229 m) = 24 lbs (10.9 kg)
 1000' (305 m) = 28 lbs (12.7 kg)

5/8" Probe

Material: Stainless steel, Buna-N, Acetal
Weight: 4.68 oz (132.5 g)
Diameter: .625" (1.59 cm)
Length: 6.125" (19.7 cm)
Minimum Conductivity
Threshold (detects water at): 10 μ S

3/8" Probe (optional)

Material: Stainless steel, Buna-N, Acetal
Weight: 1 oz (30.5 g)
Diameter: .375" (1 cm)
Length: 6.5" (16.5 cm)
Minimum Conductivity
Threshold (detects water at): 10 μ S

Tape

Material: Polyethylene coated steel tape w/ stainless steel conductors
Accuracy: 100th of a foot/100' (3 mm/30.5 m)
 Per Federal Specification: GGG-T-106E
 or
Material: MDPE tape w/ stainless steel conductors
Accuracy: 100th of a foot/100' (3 mm/30.5 m)

Reel/Frame

(300' – 500' frame)

Material: Steel & aluminum
Size: 15" H x 11.5" W x 10.5" D (38 cm H x 29 cm W x 27 cm D)

(750 – 1000' frame)

Material: Steel & aluminum
Size: 15" H x 11.5" W x 14.5" D (38 cm H x 29 cm W x 37 cm D)

Unit

Battery:	9 volt alkaline
Max power:	< 1 Watt
Max sound pressure output:	75 dB @ 30 cm

Insulation rating:

Insulation rating is considered double as there are no hazardous voltages or power circuits to pose a threat to the operator.

Battery life:	Continuously detecting: 8 hours On but not detecting: >1 year
---------------	--

Output tone:	5 kHz
--------------	-------

Operating temperature range:	32 – 140 °F (0 – 60 °C)
------------------------------	-------------------------

Operating environment:	Rated for Outdoor use.
------------------------	------------------------

Storage temperature range:	-40 – 158 °F (-40 – 70 °C)
----------------------------	----------------------------

Response time:	<10 milliseconds
----------------	------------------

Humidity:	0-100%
-----------	--------

Elevation:	-328 – 13,124' (-100 – 4000 m)
------------	--------------------------------

Tape Weight (Optional)	1" (2.54cm) OD, 4" (10.16cm) Long, 12.74oz (361g)
------------------------	--

Section 7: System Schematic

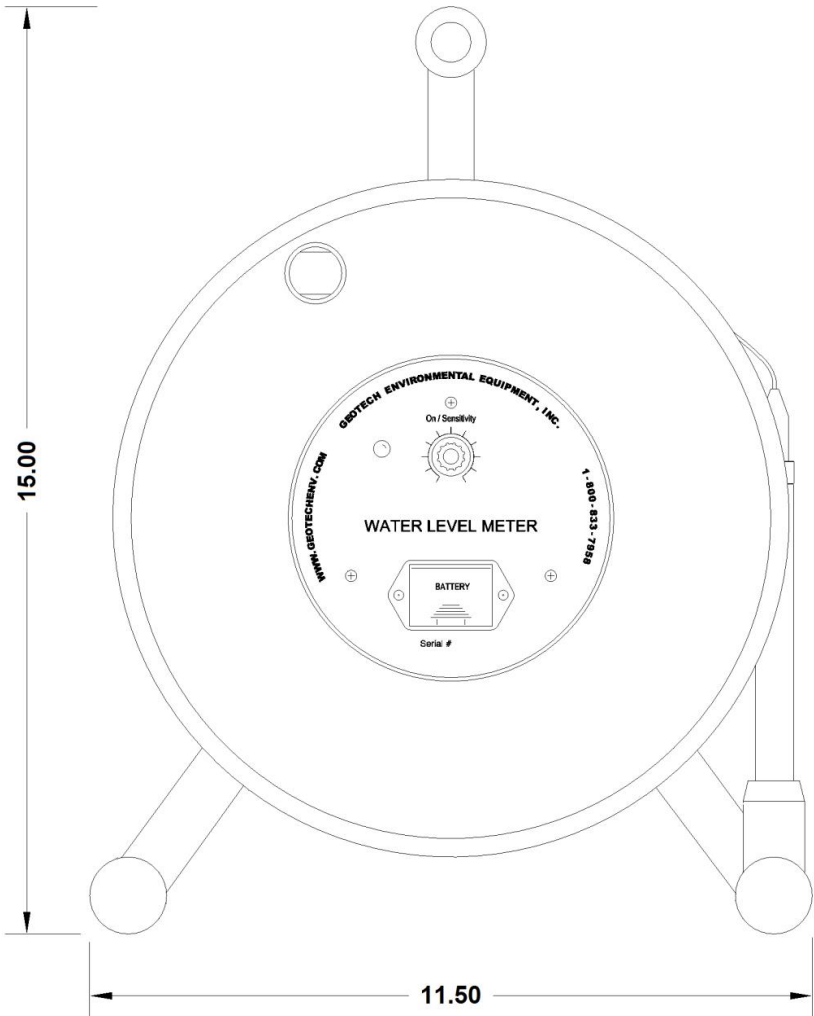

Figure 7-1: ETL Water Level Meter (front view)

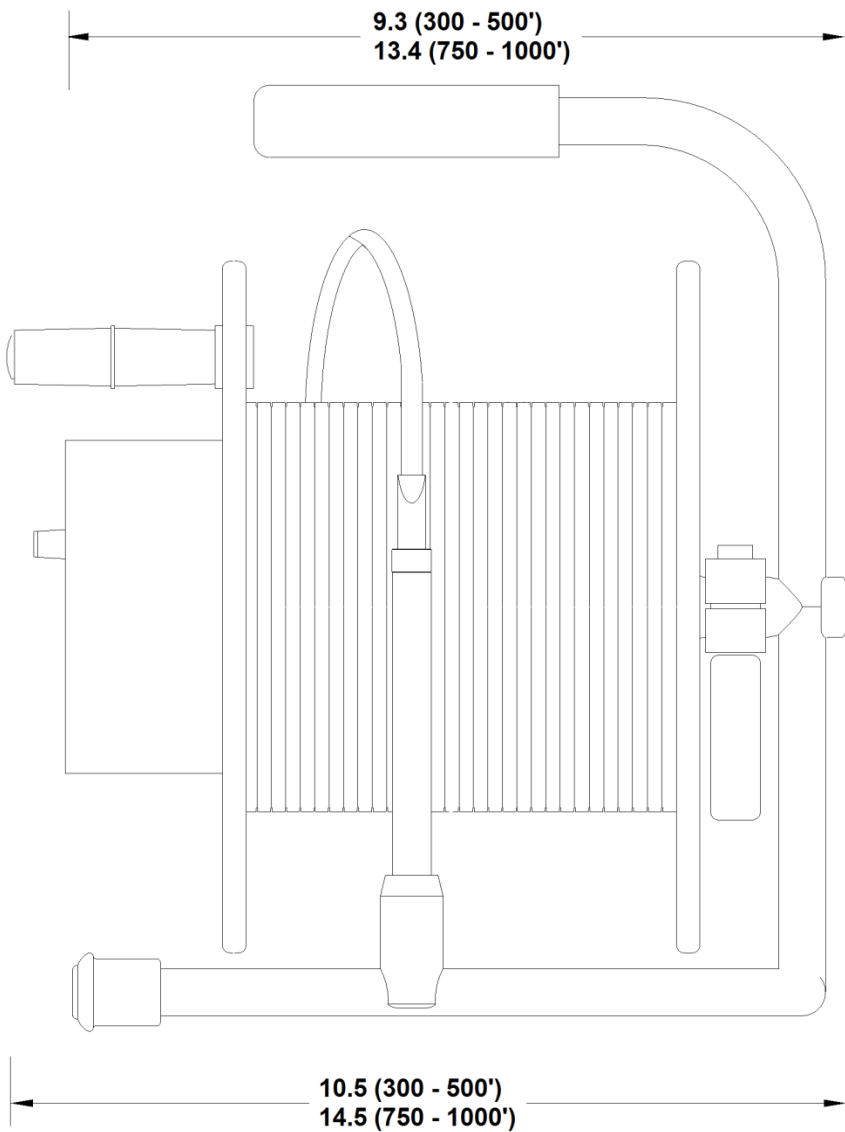
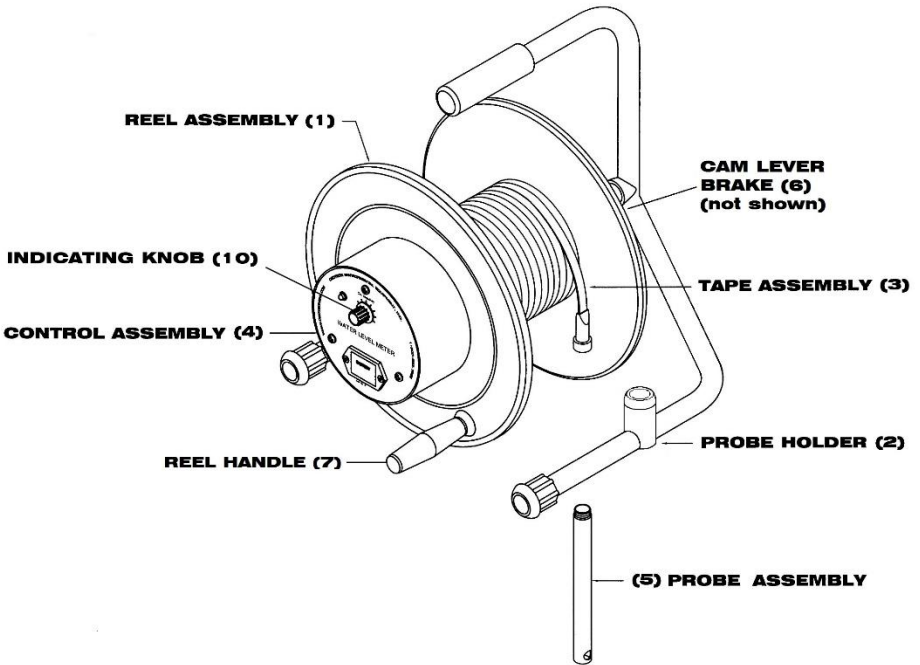

Figure 7-2: ETL Water Level Meter (side view)

Section 8: Replacement Parts List



Item #	Parts Description	Part #
1	ASSY,REEL,300-500FT,GEOWLM	52050021
	ASSY,REEL,750-1000FT,GEOWLM	52050043
2	PROBE HOLDER, 5/8", ETL	52050220
	PROBE HOLDER, 3/8", ETL FRAME	52050262
3	REPAIR,TAPE,GEOWLM,POLY,500' (5/8")	52050121
	REPAIR,TAPE,GEOWLM,POLY,750' (5/8")	52050122
	REPAIR,TAPE,GEOWLM,POLY,1000' (5/8")	52050123
	REPAIR, TAPE, WLM, MDPE, 500' (5/8")	52050221
	REPAIR, TAPE, WLM, MDPE, 750' (5/8")	52050222
	REPAIR, TAPE, WLM, MDPE, 1000' (5/8")	52050223
	REPAIR, TAPE, WLM, POLY, 500' (3/8")	52050264
	REPAIR, TAPE, WLM, POLY, 750' (3/8")	52050265
	REPAIR, TAPE, WLM, POLY, 1000' (3/8")	52050266
	REPAIR, TAPE, WLM, MDPE, 500' (3/8")	52050267
	REPAIR, TAPE, WLM, MDPE, 750' (3/8")	52050268
	REPAIR, TAPE, WLM, MDPE, 1000' (3/8")	52050269
4	ASSY,CONTROL,GEOWLM	52050140
5	ASSY,PROBE,GEOWLM (5/8")	52050052
6	BRAKE,CAM LEVER DRAG,ETL	11400070
7	HANDLE,MANUAL CRANK,W/HDWR	12050624
8	O-RING, BUNA, .484 X .039	12050961
9	WASHER, WAVE	12050255
10	KNOB, INDICATING, 1/4", RND	12050090
Not shown:		
	GUARD,LEADER,PROPAMIDE,NATURAL	12050060
	GUIDE,TAPE,DELRIN	22050255
	BAG, WLM/IP, 500-1000'	12050113
	MANUAL,INSTRUCTION,ETL	12050319
	TAPE WEIGHT (OPTIONAL)	52050277

NOTES

DOCUMENT REVISIONS		
EDCF#	DESCRIPTION	REV/DATE
-	Previous Release	8/31/2012
-	Updated 3/8" probe specs, updated EC Declaration of Conformity, updated international office address, SP	3/14/2014
-	Updated EC Declaration of Conformity, correct backpage footer information, SP	03/03/2015
#1999	Updated part numbers in Replacement Parts, Updated image to indicate part, minor style changes, SR	11/07/2016
#2018	New part number for the brake, cam lever drag, ETL; minor style changes	1/23/2017
Project 1947	Changes to PFAS Free components – StellaR	5/4/2020
Project 2016	Changed tape guide PN from PVC to Delrin (22050601 to 22050255) – StellaR	7/27/2020
Project 2281	Updated CE Document. Removed Spanish address in footer – AH	6/16/2023

EC Declaration of Conformity

Manufacturer:

Geotech Environmental Equipment, Inc.
2650 E 40th Avenue
Denver, CO 80205

Declares that the following products,

Product Name: Water Level Meter, manual rewind only

Model(s): ET Water Level Meter
ETL Water Level Meter

Year of manufacture: 2023

Conform to the principle safety objectives of 2006/95/EC Low Voltage Directive by application of the following standards:

61010-1 Ed. 9.0 en:2018
809-1 + A1:2010

Year of affixation of the CE Marking: 2023

Conform to the protection requirements of 2004/108/EC Electromagnetic Compatibility (EMC) by application of the following standards:

61000-6-1:2019
61000-6-3:2022
61326-1:2020

EMC conformity established 6/15/2023

Production control follows the ISO 9001:2015 regulations and includes required safety routine tests.

This declaration issued under the sole responsibility of Geotech Environmental Equipment, Inc.

A handwritten signature in cursive script that reads "Joseph Leonard".

Joe Leonard
Product Development

Serial number _____

The Warranty

For a period of one (1) year from date of first sale, product is warranted to be free from defects in materials and workmanship. Geotech agrees to repair or replace, at Geotech's option, the portion proving defective, or at our option to refund the purchase price thereof. Geotech will have no warranty obligation if the product is subjected to abnormal operating conditions, accident, abuse, misuse, unauthorized modification, alteration, repair, or replacement of wear parts. User assumes all other risk, if any, including the risk of injury, loss, or damage, direct or consequential, arising out of the use, misuse, or inability to use this product. User agrees to use, maintain and install product in accordance with recommendations and instructions. User is responsible for transportation charges connected to the repair or replacement of product under this warranty.

Equipment Return Policy

A Return Material Authorization number (RMA #) is required prior to return of any equipment to our facilities, please call our 800 number for appropriate location. An RMA # will be issued upon receipt of your request to return equipment, which should include reasons for the return. Your return shipment to us must have this RMA # clearly marked on the outside of the package. Proof of date of purchase is required for processing of all warranty requests.

This policy applies to both equipment sales and repair orders.

FOR A RETURN MATERIAL AUTHORIZATION, PLEASE CALL OUR
SERVICE DEPARTMENT AT 1-800-833-7958.

Model Number: _____

Serial Number: _____

Date of Purchase: _____

Equipment Decontamination

Prior to return, all equipment must be thoroughly cleaned and decontaminated. Please make note on RMA form, the use of equipment, contaminants equipment was exposed to, and decontamination solutions/methods used. Geotech reserves the right to refuse any equipment not properly decontaminated. Geotech may also choose to decontaminate the equipment for a fee, which will be applied to the repair order invoice.



Geotech Environmental Equipment, Inc
2650 East 40th Avenue Denver, Colorado 80205
(303) 320-4764 • (800) 833-7958 • FAX (303) 322-7242
email: sales@geotechenv.com
website: www.geotechenv.com

Printed in the United States of America