

# RadMan 2LT/2XT

## Personal radiation monitor

Operating manual



NEED HELP?



SCAN OR CLICK HERE  
TO CONTACT US

  
Air-Met Scientific  
www.airmet.com.au

**narda**   
Safety Test Solutions

Narda Safety Test Solutions GmbH  
Sandwiesenstrasse 7  
72793 Pfullingen, Germany

® Names and Logo are registered trademarks of  
Narda Safety Test Solutions GmbH - Trade names  
are trademarks of the owners.

© 2022

Order no.: 2280/98.21

Published: 01/2022

Earlier edition: 08/2021

Subject to change.

Our normal guarantee and delivery terms apply.

Printed in Germany

---

# Contents

<b>1</b>	<b>About this operating manual</b> .....	<b>5</b>
1.1	Language of the user interface .....	5
1.2	Used characters and symbols .....	5
<b>2</b>	<b>General safety instructions</b> .....	<b>7</b>
2.1	Electromagnetic fields .....	7
2.2	Using batteries .....	7
2.3	Device malfunctions .....	8
2.4	Intended use .....	8
<b>3</b>	<b>Unpacking</b> .....	<b>9</b>
3.1	Included in the case .....	10
<b>4</b>	<b>About this device</b> .....	<b>11</b>
4.1	Comparison of key features .....	11
4.2	Device overview .....	12
4.3	The operating modes .....	13
4.4	Standard conformity .....	14
4.5	Sensor technology .....	14
4.6	Body effects .....	14
4.7	Assembly and fastening .....	15
<b>5</b>	<b>Operation</b> .....	<b>18</b>
5.1	Display and operating elements .....	18
5.2	Power supply .....	19
5.3	Switching the device on/off .....	21
5.4	Displaying the charge state .....	22
5.5	Switching the integration time (RadMan 2XT only) ..	23

5.6	Changing the operating mode (RadMan 2XT only) . . .	24
5.7	Displaying the maximum exposure . . . . .	24
<b>6</b>	<b>Data logger . . . . .</b>	<b>25</b>
<b>7</b>	<b>RadMan 2-TS PC software . . . . .</b>	<b>26</b>
<b>8</b>	<b>Device firmware . . . . .</b>	<b>28</b>
<b>9</b>	<b>Cleaning, maintenance, repair. . . . .</b>	<b>29</b>
9.1	Cleaning . . . . .	29
9.2	Performing calibration . . . . .	29
9.3	Warning messages and troubleshooting in the event of faulty self-test. . . . .	30
9.4	Changing the batteries . . . . .	31
9.5	Repair . . . . .	32
<b>10</b>	<b>Disposal. . . . .</b>	<b>33</b>
10.1	Disposing of RadMan 2 . . . . .	33
<b>11</b>	<b>Technical data. . . . .</b>	<b>34</b>
11.1	Product properties . . . . .	34
11.2	Declaration of conformity. . . . .	38
<b>12</b>	<b>Ordering information . . . . .</b>	<b>39</b>
12.1	Radiation monitor sets. . . . .	39
12.2	Optional accessories . . . . .	40
<b>13</b>	<b>RadMan 2LT quick reference guide . . . . .</b>	<b>42</b>
<b>14</b>	<b>RadMan 2XT quick reference guide . . . . .</b>	<b>44</b>

---

# 1 About this operating manual

## 1.1 Language of the user interface

In this operating manual, the user interface is described using English terms.

## 1.2 Used characters and symbols

In this operating manual, various elements are used to indicate special text meanings or especially important text passages.

### Symbols and terms used in warnings

In accordance with American National Standard ANSI Z535.6-2011, the following warnings, symbols and terms are used in this document:

	The general danger symbol warns of risk of serious injury when used with the signal words <b>CAUTION</b> , <b>WARNING</b> and <b>DANGER</b> . Follow all the instructions in order to avoid injuries or death.
<b>NOTICE</b>	Indicates a hazardous situation which, if not avoided, results in damage to or destruction of the device.
<b>CAUTION</b>	Indicates a hazardous situation which, if not avoided, could result in minor or moderate injury.
<b>WARNING</b>	Indicates a hazardous situation which, if not avoided, could result in death or serious injury.
<b>DANGER</b>	Indicates a hazardous situation which, if not avoided, will result in death or serious injury.

### Structure of warnings

#### **SIGNAL WORD**

##### **Type and source of the danger**

##### **Consequences resulting from non-observance**

⇒ Action for danger avoidance

### Symbols and marks

✓	<b>Prerequisite</b> Indicates a prerequisite that must be satisfied before one of the following actions is performed, e.g.: ✓ You are in the measurement display.
⇒	<b>Action</b> Indicates a single action, e.g.: ⇒ Switch on device.
1. 2. 3.	<b>Sequence of actions</b> Indicates a sequence of actions that must be performed in the specified order.
↵	<b>Result</b> Indicates the result of an action, e.g.: ↵ The device starts a self-test.
<b>Bold text</b>	<b>Operating element or menu name</b> Indicates operating elements and menu names, e.g.: ⇒ Press the <b>OK</b> button.
<b>NOTE:</b>	Important additional information or notes regarding exceptions and special cases.

---

## 2 General safety instructions

### 2.1 Electromagnetic fields

#### **WARNING**

##### **Strong electromagnetic fields**

**Very strong electromagnetic fields occur near many radiation sources.**

- ⇒ Observe safety barriers and markings.
- ⇒ In particular, persons with electronic implants must keep away from dangerous areas.

### 2.2 Using batteries

#### **CAUTION**

##### **Unsuitable environmental conditions**

**Excessively high temperatures and air humidity can result in a short circuit that can start a fire. Injuries or destruction of the batteries may result.**

- ⇒ Observe the data sheet for storing the device and batteries.
- ⇒ Periodically check whether the storage temperature and air humidity are within the specified limits.
- ⇒ Do not leave discharged batteries in the measurement device for extended periods of time.
- ⇒ Do not store the batteries for longer than six months without charging from time to time.
- ⇒ The batteries must not be stored with other metal objects.
- ⇒ Long storage reduces the capacity of the battery and shortens the expected functional life. The housing can also be damaged from within by escaping electrolyte.

## 2.3 Device malfunctions

### **NOTICE**

#### **Malfunction**

**Improper use, damages and unauthorized repairs can affect the accuracy and function of the device.**

- ⇒ Only operate the device under the conditions and for the purposes for which it was designed.
- ⇒ Periodically inspect the device for damages.
- ⇒ Only have repairs performed by specialists.

## 2.4 Intended use

The RadMan 2LT/2XT radiation monitors are warning devices for the protection of people who work in areas where increased levels of electromagnetic radiation are present. Broadcasting, telecommunications and radar antennas are examples of sources of strong high-frequency radiation. Transmission systems can often not be completely shut down. Should this be necessary, a check must be performed to determine whether the shutdown has actually occurred. In these situations, a personal monitor provides safety. The device is worn on the body and warns the user in good time before the impermissible limit values are exceeded. RadMan 2LT and RadMan 2XT comply with the recommendations of ITU-T K.145 with regard to the use and properties of RF personal monitors.



---

## 3 Unpacking

The packaging is designed so that it can be reused if not damaged during a prior transport. Thus, the original packaging can be used in all further transports.

The device and accessory parts may exhibit transport damages especially if the packaging has already been clearly damaged.

### **Check for completeness and damages:**

- ⇒ Remove device and accessories from the case and check for completeness as well as any transport damages.

### **CAUTION! Do not operate a damaged device.**

- ⇒ In the event of an incomplete delivery and damages to the device or accessories, please contact your Narda sales partner. You can find the Narda sales partner responsible for you on the Narda website at [www.narda-sts.com](http://www.narda-sts.com).

## 3.1 Included in the case

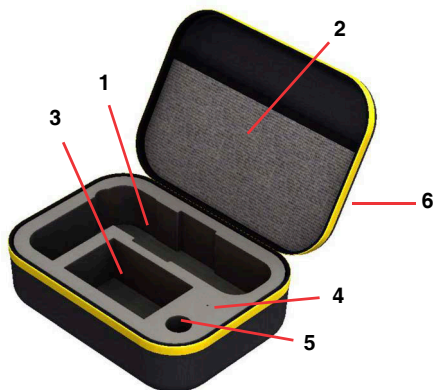

No.	Description
1	RadMan 2LT/2XT Basic unit with two installed batteries and mounting adapter
2	USB-2.0 cable, Operating manual, Fastening strap and Lanyard
3	Power supply with manufacturer's manual (optional)
4	Allen wrench 1.5 mm
5	Car charger adapter (optional)
6	Carrying case

For further information on orders, scope of delivery and optional accessories, see *Ordering information* on page 39.

---

## 4 About this device

The RadMan 2LT/2XT monitors are worn on the body and warn of electromagnetic radiation. As part of the exposure determination, the device outputs acoustic, vibration and LED warning signals as soon as the limit values defined in the standards are exceeded.

### 4.1 Comparison of key features

RadMan 2LT	RadMan 2XT
Frequency range up to 8 GHz	Expanded frequency range (up to 60 GHz) enables warning of excessive microwave signals, radar signals and 5G millimeter waves
Monitoring of E-fields and H-fields with frequency response evaluation	
Automatic sensor function test when switching on	
800 hours of operating time with one battery charge	
USB-C interface for fast data transfer and for charging the batteries	
RF absorber minimizes body effects	
Isotropic monitoring away from the body by simply releasing from the holder	
Tripod thread for mounting an extension rod	
Data logger	Data logger with increased memory capacity and configurable recording intervals
Fixed integration time of 1 s	Switchable integration time (1 s/30 ms)
–	RF Detection Mode with tone search function (RF detection) for precise localization of leaks

## 4.2 Device overview



Figure 1: Product views of RadMan 2XT and mounting adapter

No.	Description
1	LED display: exposure in %, power, pulse (2XT only), battery status
2	Isotropic E & H sensors with automatic functional test
3	Large illuminated alarm display
4	Simple one-button operation
5	Battery compartment with 5a) tripod thread and 5b) USB-C charging and data connection
6	Rear view of the device with product label
7	Mounting adapter (holder) with absorber

## 4.3 The operating modes

In addition to the standard **Monitor** operating mode of the RadMan 2LT, RadMan 2XT offers the **RF Detection** operating mode.

	<b>Monitor</b>	<b>RF Detection (2XT only)</b>
<b>Application</b>	<ul style="list-style-type: none"> <li>Warning: Electromagnetic radiation</li> </ul>	<ul style="list-style-type: none"> <li>Detection of high-freq. cont. signals or pulsed signals</li> <li>Leakage search on waveguides</li> <li>Check to determine whether antennas are actually switched off</li> </ul>
<b>Integration time</b>	<ul style="list-style-type: none"> <li>2LT: 1 s</li> <li>2XT: 1 s of 30 ms</li> </ul>	<ul style="list-style-type: none"> <li>30 ms</li> </ul>
<b>Field exposure display</b>	<ul style="list-style-type: none"> <li>5 – 200%, individual red LED indicates measurement value for E- or H-field (whichever is higher)</li> </ul>	<ul style="list-style-type: none"> <li>5 – 200%, red LEDs as bar display</li> <li>Acoustic signal above 5%, sound becomes higher with increasing value</li> </ul>
<b>Alarm threshold 1</b> 50% exposure and higher <sup>1)</sup>	<ul style="list-style-type: none"> <li>Alarm LED flashes slowly</li> <li>Alarm signal sounds slowly</li> <li>Slow vibration</li> </ul>	<ul style="list-style-type: none"> <li>Alarm LED flashes slowly</li> <li>Slow vibration</li> </ul>
<b>Alarm threshold 2</b> 100% exposure and higher <sup>1)</sup>	<ul style="list-style-type: none"> <li>Alarm LED flashes rapidly</li> <li>Alarm signal sounds rapidly</li> <li>Fast vibration</li> </ul>	<ul style="list-style-type: none"> <li>Alarm LED flashes rapidly</li> <li>Fast vibration</li> </ul>
<b>Data logger</b>	<ul style="list-style-type: none"> <li>Activated</li> </ul>	<ul style="list-style-type: none"> <li>Deactivated</li> </ul>

1) The alarm signals switch off once the limit values are no longer exceeded. For optioned models, the alarm thresholds can be set using a PC.

### 4.4 Standard conformity

The permissible limit values specified in the standards are frequency-dependent. Weighting filters in the sensors of the RadMan 2 simulate the frequency response of the standard. They ensure that the alarm thresholds are correct over the entire frequency range. Settings are not necessary. Underlying safety standards:

- ICNIRP 1998 / Occupational (corresponds to Directive 2013/35/EU)
- FCC 96-326 / Occupational
- Canada Safety Code 6 (2015) / Controlled
- ICNIRP 1998 / General Public, E-Field (RadMan 2LT only)

### 4.5 Sensor technology

At close range to a radiation source, the otherwise fixed relationship between an electric field and magnetic field no longer applies. Both field types must therefore be checked. RadMan 2 is equipped with E-field and H-field sensors and thus warns reliably, independent of the distance to the radiation source.

#### Automatic sensor test

The newly developed sensor test tests the proper function of the individual sensors each time the device is switched on. The device no longer needs to be tested with a test generator prior to beginning work.

### 4.6 Body effects

The radiation monitors are mainly worn on the body. For simple fastening to a climbing harness or belt, RadMan 2 includes a suitable holder with integrated RF absorber. The RF absorber reduces the signal reflections caused by the body that would affect the results output by the monitor. If necessary, the RadMan 2 can be removed from the holder with one hand to determine the field exposure off the body with isotropic directional response. An elastic safety lanyard between the device and holder protects the device from falling down.

## 4.7 Assembly and fastening

### 4.7.1 Attaching the safety lanyard

Monitor and mounting adapter (holder) can be connected to one another using a safety lanyard. This protects the monitor from falling down if it is removed from the case attached to the body. The safety lanyard can very easily be removed from the holder by means of a carabiner.

#### Connecting the safety lanyard to the monitor

1. Fold down the cover cap on the bottom of the housing and push the mounting loop through the opening of the cover cap.
2. Thread the mounting loop through the opening above the threaded connection and pull up and out on the rear side.
3. Pull safety lanyard through the eyelet of the mounting loop.
4. Place loop around the two notches at the front.
5. Tighten the loop.
6. Close the cover cap again.

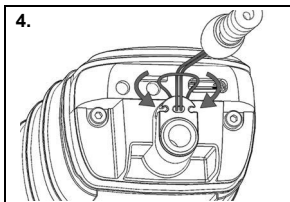
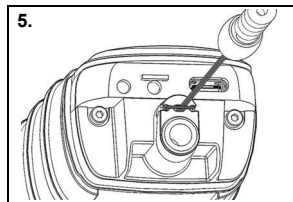
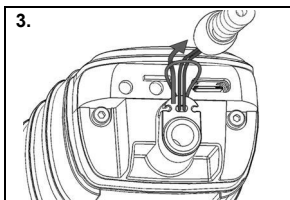
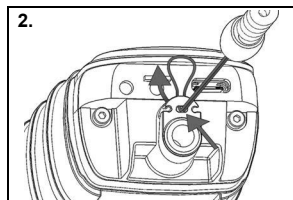

### Connecting the safety lanyard to the mounting adapter

The safety lanyard is secured to the mounting adapter via the carabiner.

- ✓ Monitor is separated from the mounting adapter.
- ⇒ Push the carabiner into the mounting adapter from below and attach to the bracket.

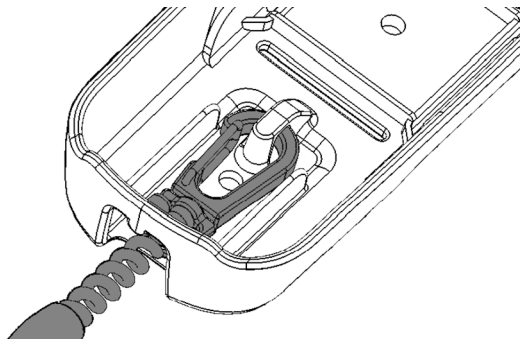

**NOTE:** By releasing the carabiner, the monitor can easily be removed from the mounting adapter. The monitor is then no longer protected against falling down, however!



## 4.7.2 Fastening the monitor to the body

The mounting adapter is intended to be attached to a climbing harness or a belt. For this purpose, the mounting adapter is secured to the desired position with the supplied fastening strap. The buckle allows the mounting adapter to be attached and released quickly.

### Attaching the mounting adapter:

1. Guide the fastening strap through the two slots of the mounting adapter (Figure 2, **a**):
  - **To fasten to a climbing harness:** use longitudinal slots.  
The buckle should be located to the right of the mounting adapter and the fastening tab should point upward.
  - **To fasten to a belt:** use horizontal slots.  
The buckle should be located at the bottom and the fastening tab should point upward.
2. Place the fastening strap around the climbing belt strap or the belt and thread through the buckle.  
The end of the strap is sewn down to prevent the device from accidentally slipping out (Figure 2, **b**). When releasing the strap, press the sewn-down part against the strap and pull out of the buckle.
3. Tighten the fastening strap and close the buckle (Figure 2, **c**).

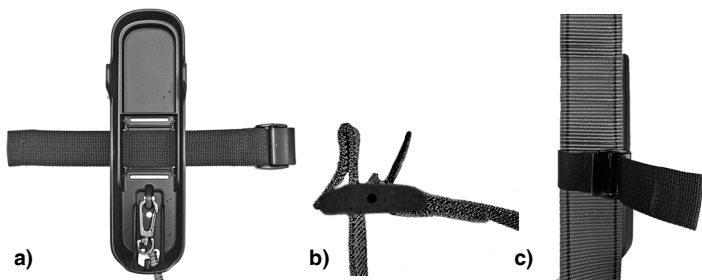











Figure 2: Attaching the mounting adapter

# 5 Operation

## 5.1 Display and operating elements

Element	Name	Function
	<b>Operating button</b> On the device side (see figure 1, 4)	<ul style="list-style-type: none"><li>• Switch on/off</li><li>• Select operating modes (2XT)</li><li>• Select integration times (2XT)</li><li>• Display maximum exposure</li></ul>
5...200% 	<b>Exposure LEDs</b>	6 red LEDs for displaying: <ul style="list-style-type: none"><li>• Exposure (5/10/25/50/100/200%)</li><li>• Charge state</li><li>• Error codes</li></ul>
	<b>Alarm LED</b>	Flashes red in the event of an alarm.
 	<b>Power LED</b>	Flashes green during operation.
 Pulse	<b>Pulse LED</b> (RadMan 2XT only)	Illuminates red: <ul style="list-style-type: none"><li>• in Monitor Mode: integration time = 30 ms</li><li>• in RF Detection Mode</li></ul>
   	<b>Battery status LED</b>	While charging: <ul style="list-style-type: none"><li>• flashes green: batteries are charging</li><li>• illuminates green: batteries are fully charged</li></ul> In operation: <ul style="list-style-type: none"><li>• illuminates green: after switching on, as long as the remaining capacity is displayed</li><li>• flashes red: remaining capacity &lt; 5%</li></ul>

## 5.2 Power supply

As standard, power is supplied by two NiMH batteries of type AA (Mignon).

### 5.2.1 Operation with batteries

The device is delivered with partially charged batteries. The batteries must be fully charged prior to the first use, however. Charging can be performed at the USB-C connection via a suitable USB port (e.g., on a PC) or with a standard USB charger (min. 500 mA charging current). The fully charged batteries can supply power for an operating duration of approx. 800 hours (without alarm).

**NOTE:** Already a short battery charging time of approx. 5 minutes allows the device to be used for up to 8 hours.

### 5.2.2 Operation with non-rechargeable batteries

**NOTE:** Operation with non-rechargeable batteries is **not recommended**, but is, in principle, possible.

Regardless of the use of non-rechargeable batteries, charging is started when a USB connection is made or when the charger is connected. Therefore, be certain to observe the following warning instruction.

#### CAUTION

##### **Use of non-rechargeable batteries**

**When using non-rechargeable batteries, establishing a USB connector or connecting the charger results in an impermissible charging process. This may cause the batteries to explode and lead to severe injuries.**

- ⇒ If non-rechargeable batteries are used, do not establish a USB connection and do not connect the charger.
- ⇒ Only use non-rechargeable batteries if absolutely necessary and replace with rechargeable batteries as quickly as possible.

### 5.2.3 Charging batteries

#### CAUTION

##### **Improper charging and discharging**

**Improper charging or discharging may result in an explosion, a fire or the release of chemical substances. This may lead to injuries or the destruction of the batteries.**

- ⇒ Only charge the rechargeable batteries as described in this operating manual.
- ⇒ The charging temperature must be between 0 °C and +40 °C.

##### **Starting the charging process:**

- ⇒ Connect the USB-C connection of the RadMan 2 to a suitable USB port (e.g., PC) using the supplied USB cable.

– or –

Connect the USB-C connection of the RadMan 2 to the power grid using one of the optionally available chargers or other standard charger.

**ATTENTION! The mains voltage must correspond to the permissible operating voltage of the charger.**

- ↻ The charging process begins; the **Battery** LED flashes green during the charging process. It takes up to 8 hours to fully charge.
- ↻ Once the rechargeable batteries are fully charged, the **Battery** LED illuminates green continuously.

For further information on the various battery status displays, see *Displaying the charge state* on page 22.

## 5.3 Switching the device on/off

### 5.3.1 Switch on the device

⇒ Press the **operating button** for at least 1 s.

Each time the device is switched on, an automatic self-test including sensor function test is performed. During the self-test, all LEDs must illuminate for 3 seconds. The remaining capacity of the rechargeable batteries is then displayed for 3 seconds; the battery status LED also illuminates green during this time. Afterwards, the self-test is concluded and the green Power LED flashes. The following results are possible:

Signals	Result/measures
<ul style="list-style-type: none"> <li>• 1 short beep</li> </ul>	<ul style="list-style-type: none"> <li>✓ No errors were detected and the device is fully functional.               <ul style="list-style-type: none"> <li>↳ The device switches to the Monitor operating mode.</li> </ul> </li> </ul>
<ul style="list-style-type: none"> <li>• 3 short beeps: ---</li> <li>• <b>Battery status LED</b> flashes red</li> </ul>	<ul style="list-style-type: none"> <li>✓ No errors were detected and the device is fully functional.</li> <li>✓ Battery with remaining capacity &lt; 5%               <ul style="list-style-type: none"> <li>↳ The device switches to the Monitor operating mode.</li> <li>↳ The rechargeable batteries should be charged within the next 10 hours (see <i>Charging batteries</i> on page 20).</li> </ul> </li> </ul>

Signals	Result/measures
<ul style="list-style-type: none"><li>• 3 short beeps: ---</li><li>• Individual <b>exposure LEDs</b> flash for 5 s</li></ul>	<p>⚠ <b>At least one error</b> has occurred; the device can be used, however.</p> <ul style="list-style-type: none"><li>↳ The device switches to the Monitor operating mode.</li></ul> <p>⇒ For warning messages, see page 30.</p>
<ul style="list-style-type: none"><li>• 3 x 3 short beeps: --- --- ---</li><li>• All 6 <b>exposure LEDs</b> flash</li></ul>	<p>⚠ A <b>serious error</b> has occurred.</p> <p>⇒ Do not use the device; switch it off.</p> <ul style="list-style-type: none"><li>↳ The device must be repaired (see <i>Repair</i> on page 32).</li></ul>

### 5.3.2 Switch off the device

⇒ Press the **operating button** for at least 2 s.

- ↳ The alarm LED illuminates.
- ↳ A long beep sounds.
- ↳ The device is switched off.

## 5.4 Displaying the charge state

The charge state is displayed in the individual operating phases to provide information about the remaining charge capacity at all times:

### When switching on the device

-  illuminates green.
- The exposure LEDs display the remaining capacity as a bar.
- After 3 s, the display changes to the **Monitor** operating mode.

### In operation

#### Charge state > 5% remaining capacity

- No display

**Charge state < 5% remaining capacity**

-  flashes red.
- ⇒ The rechargeable batteries should be charged within the next 10 hours (see *Charging batteries* on page 20).

**When charging****During charging:**

-  flashes green.
- While switched off, the exposure LEDs indicate the already charged capacity as a bar.



**After completing the charging process:**

-  illuminates green.
- The exposure LEDs illuminate as a bar up to 100%.

## 5.5 Switching the integration time (RadMan 2XT only)

In the Monitor operating mode, the integration time of the measurement can be set to 1 s or 30 ms. For the reliable detection of brief or pulsed fields, the short integration time of 30 ms is recommended.



**Setting the integration time:**

- ✓ The device is switched on and in the Monitor operating mode (default).
  - ✓ After switching on, the integration time is set to 1 s.
- ⇒ Press  3x.
- ↻ The integration time changes to 30 ms.
  - ↻ Three short beeps sound and the **Pulse** LED illuminates continuously.
- ⇒ Press  3x.
- ↻ The integration time changes back to 1 s.
  - ↻ One long beep sounds.

**NOTE:** After switching on, the last set integration time is applied.

### 5.6 Changing the operating mode (RadMan 2XT only)

With the RadMan 2XT, it is possible to switch between the Monitor and RF Detection operating modes. In the RF Detection operating mode, the integration time is permanently set to 30 ms to allow rapid changes to be detected.

- ✓ The device is switched on and in the Monitor operating mode (default).
- ⇒ Press  2x.
  - ↪ **RF Detection** is active.
  - ↪ The **Pulse** LED illuminates.
- ⇒ Press  2x again to return to the Monitor operating mode.

**NOTE:** After switching back to the Monitor operating mode, the integration time last set there is used again.

### 5.7 Displaying the maximum exposure

A maximum value display shows the highest exposure since the last time the device was switched on.

- ✓ The device is switched on.
- ⇒ Press  1x.
  - ↪ The maximum exposure is indicated by the exposure LEDs.
  - ↪ After 5 s, the display returns to the current exposure.

**NOTE:** With the RadMan 2XT, the maximum value for the two operating modes – Monitor and RF Detection – is determined separately. The maximum value of the selected operating mode is displayed.



---

## 6 Data logger

The RadMan 2 continuously stores the exposure values for the E-field and the H-field and adds a time stamp to each record. The recorded data can be read out and analyzed using the PC software (see *RadMan 2-TS PC software* on page 26).

The data logger begins recording automatically after the device is switched on. A new record is created each time the device is switched on. Recording must occur for at least 1 minute to create a record.

With the **ring memory concept**, older data is deleted after the maximum storage volume is reached. Thus, storage is not limited by time. The following table shows the available storage volumes.

	RadMan 2LT	RadMan 2XT
Recorded data	Maximum value, average value and minimum value of the exposure for each recording interval and with time stamp, separate for E-field and H-field. The average values can be adapted to different integration times later on.	
Maximum number of records	2,880 events	100,000 events
Recording interval	1 min	Factory setting: 1 min Adjustable via PC software in steps of 1 s to 6 min or can be switched off
Recording time until data is overwritten	48 h	<ul style="list-style-type: none"><li>• at 1 s: approx. 27 h</li><li>• at 1 min (default): 1,667 h (approx. 69 days)</li><li>• at 6 min: 10,000 h (approx. 416 days)</li></ul>

**NOTE:** RadMan 2XT: The data logger is deactivated in the RF Detection operating mode.

# 7 RadMan 2-TS PC software

The following functions are available:

- Read out and analyze the data stored in the data logger
- Save the data in the integrated database
- Perform live measurements of current exposure values
- Configuration of the RadMan 2 (e.g., setting the local time; CET is preset)
- Only for optioned models: display and change adjustable alarm thresholds

The software is not supplied with the device but can be downloaded free of charge from the Narda website at [www.narda-sts.com](http://www.narda-sts.com).

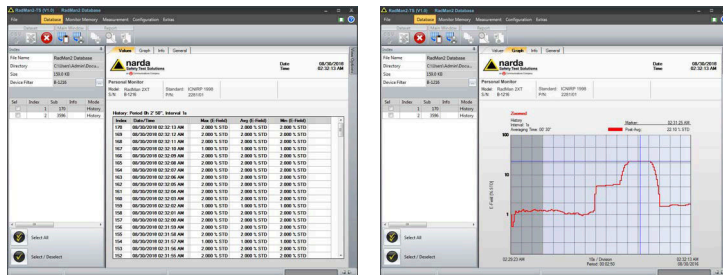

Figure 3: Tabular and graphical depiction of stored values with the help of RadMan 2-TS PC software.

**NOTE:** The RadMan 2-TS PC software can be installed on all computers with the Microsoft Windows 7 operating system or newer.

---

### Connecting the device to the PC software:

1. Download and install the PC software from [www.narda-sts.com](http://www.narda-sts.com) (installation requires administrator rights).
2. Connect the switched-off RadMan 2 to the PC using a USB cable.
3. Open the PC software.
  - ↳ The connected device is automatically detected.
4. Click on the **Connect** icon in the PC software.
  - ↳ The connection to the device is established.

The content read out from data logger can be analyzed on the PC and stored in the integrated database.

The ring memory of the data logger does not require any deletion of data. It is, however, possible to delete the data with the **Delete** icon.

Live measurements are also possible with the RadMan 2.

For optioned models, the alarm thresholds can be changed under Configuration / Setups.

⇒ You can find further information on using the PC software in the online help of the PC software.

# 8 Device firmware

When available, new firmware versions are made available for download on the [www.narda-sts.com](http://www.narda-sts.com) website.

The download consists of a flash tool as executable .exe file which the user can use to quickly and easily update the firmware.

Prerequisite for the flash tool is the installed Microsoft .NET Framework, version 3.5 or higher (included standard with Windows 7 and higher).

**NOTE:** Updating the device firmware does not require administrator rights.

### Updating firmware:

- ✓ Device is switched on or off.
- 1. Connect device to the PC with the USB cable.
- 2. Start the flash tool with the executable .exe file.
  - ↳ The firmware will be updated within 10 s.

---

## 9 Cleaning, maintenance, repair

### 9.1 Cleaning

#### **NOTICE**

##### **Unsuitable cleaning methods**

**Solvents can damage the RadMan 2 or the charger. Water can damage the charger.**

- ⇒ Do not use solvents to clean the RadMan 2 and charger. As cleaning fluid, we recommend the use of lukewarm water to which a drop of liquid detergent has been added.
- ⇒ To clean the charger, use only a slightly damp cloth. Never allow water to enter the charger.
- ⇒ If necessary, wipe down the still-damp device parts with a dry cloth.

### 9.2 Performing calibration

Narda recommends recalibrating the device after 36 months. For new devices, this recommendation applies from the date of commissioning by the customer. Depending on the conditions in which the device is used, you may independently decide to define other calibration intervals.

- ⇒ For calibration, send the device to your Narda sales partner. You can find the Narda sales partner responsible for you on the Narda website at [www.narda-sts.com](http://www.narda-sts.com).

---

## 9.3 Warning messages and troubleshooting in the event of faulty self-test

Each time the device is switched on, an automatic self-test is performed. A warning message occurs any time certain functions (with the exception of the warning function) of the device are affected. In this case, the device can continue to be used and reliably warns of excessively high electromagnetic radiation but should, however, be serviced soon.

**NOTE:** If the warning function is affected, the device can no longer be used. In this case, please contact your Narda sales partner. You can find the Narda sales partner responsible for you on the Narda website at [www.narda-sts.com](http://www.narda-sts.com).

The following table shows all possible warning messages and the possibilities for rectifying:

Signals	Error	Troubleshooting
<ul style="list-style-type: none"><li>• 3 short beeps: ---</li><li>• 5% LED flashes for 5 s</li></ul>	<b>Real Time Clock RTC incorrect</b> Device time is incorrect and reset to the default value of 2000-01-01 00:00	<ol style="list-style-type: none"><li>1. Connect device to PC.</li><li>2. Start the RadMan 2-TS PC software.</li><li>3. Resynchronize date/time.</li></ol>
<ul style="list-style-type: none"><li>• 3 short beeps: ---</li><li>• 10% LED flashes for 5 s</li></ul>	<b>Data Logger Malfunction</b> Faulty data recording by the data logger	<ol style="list-style-type: none"><li>1. Connect device to PC.</li><li>2. Start the RadMan 2-TS PC software.</li><li>3. Delete the content of the data logger in the <b>Device Memory</b> menu.</li></ol> <p>If the error message persists, the device must be repaired (see <i>Repair</i> on page 32).</p>

## 9.4 Changing the batteries

### WARNING

#### Wrong polarity

**The batteries can explode if installed with the wrong polarity. This will destroy the device.**

⇒ Observe the marking for the plus and minus pole in the battery compartment.

The batteries can be changed by the user. It may be necessary to change the batteries if the operating duration with fully charged batteries significantly decreases.

**NOTE:** Observe the regulations regarding the disposal of batteries, both rechargeable and non-rechargeable (see *Disposal* on page 33).

- ✓ Use suitable rechargeable batteries: 2x NiMH, type AA (Mignon).
- 1. Open the protective cap **(1)** on the bottom end of the RadMan 2.
- 2. Loosen 2 Allen screws **(2)** with the Allen wrench (1.5 mm).
- 3. Remove the battery cover **(3)**.
- 4. Remove and replace the rechargeable batteries **(4)**.
- 5. Mount the battery cover and tighten the Allen screws.
- 6. Close the protective cap.

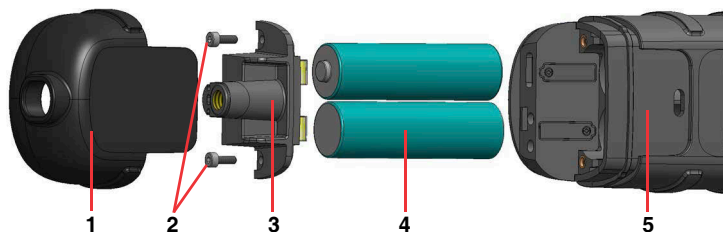

Figure 4: RadMan 2 battery compartment

No.	Description	No.	Description
1	Protective cap (Photo shows the entire cap. To change the batteries, it suffices to open the cap.)		
2	2x Allen screws	4	Batteries
3	Battery cover	5	RadMan 2

## 9.5 Repair

Repairs may only be performed by qualified specialists.

⇒ For more information, please contact your Narda sales partner or visit [www.narda-sts.com](http://www.narda-sts.com).



# 10 Disposal

## 10.1 Disposing of RadMan 2

### 10.1.1 Disposal of used equipment

The crossed-out wheeled garbage can symbol indicates that this product is subject to the European WEEE Directive 2012/19/EU on the disposal of waste electrical and electronic equipment and must be disposed of separately from household waste in accordance with your national regulations.



In the European Union, all electronic measuring systems purchased from Narda after August 13, 2005 can be returned at the end of their useful life.

⇒ For more information, please contact your Narda distributor.

### 10.1.2 Disposal of removable batteries

⇒ Batteries must not be disposed of in household waste, but must be disposed of separately from the product in accordance with the applicable regulations. They can be returned free of charge to the appropriate collection points, your dealer or directly via Narda.

⇒ Please discharge the batteries before disposal.

### 10.1.3 Disposal of permanently installed batteries

There are no permanently installed batteries in this device.

### 10.1.4 Deleting private data

⇒ Make sure that you delete any stored private data before passing on or disposing of the device.

---

# 11 Technical data

The technical specifications may change due to product developments. The latest technical specifications can be found in the datasheet of the product. The datasheet can be downloaded from the Narda website [www.narda-sts.com](http://www.narda-sts.com) under the corresponding product page.

## 11.1 Product properties

### General data

	RadMan 2LT/2XT
Recommended calibration interval	3 years, beginning 3 years after commissioning
Power supply	2 replaceable NiMH rechargeable batteries, type AA (Mignon), chargeable via USB connection.
Operating time/charge duration (typ.)	800 h operation (without alarm)/charge duration < 8 h
Temperature range	Operation: -10 °C to +55 °C (14 °F to 131 °F) Transport: -40 °C to +70 °C (-40 °F to 158 °F)
Air humidity	5% to 95%, non-condensing (≥ 29 g/m <sup>3</sup> , IEC 60721-3-2 Class 7K2)
Ingress protection	Protection class IP65 (dust-tight and protected against water jets)
Dimensions (H x W x D)	165 mm x 47 mm x 31 mm (6.5 in x 1.85 in x 1.22 in) without mounting adapter
Weight	185 g (0.4 lb) without mounting adapter
Country of origin	Germany

## Specifications

	RadMan 2LT	RadMan 2XT
Sensors	Isotropic E-field and H-field sensors, diode-based system (only E-field sensors for models for the general population)	
Directionality	Isotropic (3-axis)	
Absorber	Yes, integrated in mounting adapter	
Integration time of input signal	1 s	Switchable between 1 s and 30 ms (Pulse)
Type of frequency response	Shaped response (weighted) according to a safety standard (see <i>Ordering information</i> on page 39)	
Frequency range E-field	50 MHz to 8 GHz	<ul style="list-style-type: none"> <li>• 900 kHz to 60 GHz (ICNIRP 98 Occ models)</li> <li>• 10 MHz to 60 GHz (ICNIRP 98 GP models)</li> <li>• 3 MHz to 60 GHz (FCC models)</li> <li>• 10 MHz to 60 GHz (SC6 models)</li> </ul>
Frequency range H-field	50 MHz to 1 GHz	<ul style="list-style-type: none"> <li>• 27 MHz to 1 GHz (ICNIRP 98 Occ, SC6 models)</li> <li>• 3 MHz to 1 GHz (FCC models)</li> </ul>
Sensitivity	< 1% of standard	
Display	<ul style="list-style-type: none"> <li>• 6 level LEDs</li> <li>• 1 power LED</li> <li>• 1 battery LED</li> </ul>	<ul style="list-style-type: none"> <li>• 6 level LEDs</li> <li>• 1 power LED</li> <li>• 1 pulse LED</li> <li>• 1 battery LED</li> </ul>

	<b>RadMan 2LT</b>	<b>RadMan 2XT</b>
RF exposure display	5/10/25/50/100/200% of standard (with respect to the power density)	
Alarm display	<ul style="list-style-type: none"> <li>• Visual: %-level LEDs, 2 bright alarm LEDs (270° viewing angle)</li> <li>• Audio: alarm buzzer and vibration</li> </ul>	
Alarm thresholds	<ul style="list-style-type: none"> <li>• Alarm 1: 50%</li> <li>• Alarm 2: 100%</li> <li>• Thresholds adjustable via PC from 10% to 310% (optioned models only)</li> </ul>	
Alarm signal	<ul style="list-style-type: none"> <li>• Alarm 1: 2 Hz buzzer/light/vibration</li> <li>• Alarm 2: 4 Hz buzzer/light/vibration</li> </ul>	
Overload limit (sinusoidal continuous signal)	20 dB over standard, but not more than 10 kV/m or 26.5 A/m	
Overload limit (impulse signals)	40 dB over standard for pulse widths < 10 µs, but not more than 100 kV/m or 265 A/m	
ELF immunity at 50/60 Hz	10 kV/m	
Data interface	USB type C	

**Data logger (ring memory)**

Number of records	2,880 events	100,000 events
Recording intervals	1 min	Factory setting: 1 min, via PC 1 s to 6 min or off
Recording time	48 h	Approx. 27 h to approx. 416 days
Recorded data	Exposure values max./avg./min. with time stamp, separate for E-field and H-field	

## Frequency response/isotropy

Field	RadMan 2LT	RadMan 2XT
<b>ICNIRP 1998, General Public</b>		
E	±3.5 dB (50 MHz to 8 GHz)	<ul style="list-style-type: none"> <li>• ±3 dB (10 MHz to 10 GHz)</li> <li>• +6/-3 dB (&gt; 10 to 20 GHz)</li> <li>• +10/-3 dB (&gt; 20 to 60 GHz)</li> </ul>
<b>ICNIRP 1998, Occupational</b> (corresponds to Directive 2013/35/EU)		
E	±3.5 dB (50 MHz to 8 GHz)	<ul style="list-style-type: none"> <li>• ±3 dB (900 kHz to 10 GHz)</li> <li>• +6/-3 dB (&gt; 10 to 20 GHz)</li> <li>• +10/-3 dB (&gt; 20 to 60 GHz)</li> </ul>
H	±3 dB (50 MHz to 1 GHz)	±3 dB (27 MHz to 1 GHz)
<b>ICNIRP 2020, General Public</b>		
E	±3.5 dB (50 MHz to 8 GHz)	<ul style="list-style-type: none"> <li>• ±3 dB (27 MHz to 10 GHz)</li> <li>• +6/-3 dB (&gt; 10 to 20 GHz)</li> <li>• +10/-3 dB (&gt; 20 to 60 GHz)</li> </ul>
<b>ICNIRP 2020, Occupational</b>		
E	±3.5 dB (50 MHz to 8 GHz)	<ul style="list-style-type: none"> <li>• ±3 dB (27 MHz to 10 GHz)</li> <li>• +6/-3 dB (&gt; 10 to 20 GHz)</li> <li>• +10/-3 dB (&gt; 20 to 60 GHz)</li> </ul>
H	±3 dB (50 MHz to 1 GHz)	±3 dB (1 MHz to 1 GHz)
<b>FCC 96-326, Occupational</b>		
E	±3.5 dB (50 MHz to 8 GHz)	<ul style="list-style-type: none"> <li>• ±3 dB (3 MHz to 10 GHz)</li> <li>• +6/-3 dB (&gt; 10 to 20 GHz)</li> <li>• +10/-3 dB (&gt; 20 to 60 GHz)</li> </ul>
H	±3 dB (50 MHz to 1 GHz)	±3 dB (3 MHz to 1 GHz)

Field	RadMan 2LT	RadMan 2XT
<b>Safety Code 6 (2015), Controlled</b>		
E	<ul style="list-style-type: none"> <li>• +4/-3 dB (50 MHz to 3 GHz)</li> <li>• +6/-3 dB (3 GHz to 8 GHz)</li> </ul>	<ul style="list-style-type: none"> <li>• +4/-3 dB (10 MHz to 10 GHz)</li> <li>• +6/-3 dB (&gt; 10 to 20 GHz)</li> <li>• +11/-3 dB (&gt; 20 to 60 GHz)</li> </ul>
H	+4/-3 dB (50 MHz to 1 GHz)	+4/-3 dB (27 MHz to 1 GHz)
<b>Isotropic response</b>		
E	±1 dB (< 2.7 GHz)	
H	±1.5 dB (< 500 MHz)	

**NOTE:** Values in the positive range of the frequency response mean an early warning.

## 11.2 Declaration of conformity

Hereby, Narda STS declares that this equipment is in compliance with the directives 2014/30/EU, EN 61326-1:2013, 2014/35/EU, EN 61010-1:2010, and 2011/65/EU.

The full text of the EU declaration of conformity is available at [www.narda-sts.com](http://www.narda-sts.com).

# 12 Ordering information

## 12.1 Radiation monitor sets

Model designation	Part no.
<b>RadMan 2LT – personal monitor sets 8 GHz</b>	
RadMan 2LT, ICNIRP 1998 / Occupational <sup>1) 2)</sup>	2280/101
RadMan 2LT, FCC 96-326 / Occupational	2280/102
RadMan 2LT, SC 6 (2015) / Controlled	2280/103
RadMan 2LT, ICNIRP 1998 / General Public, E-Field <sup>2)</sup>	2280/111
<b>RadMan 2XT – personal monitor sets 60 GHz</b>	
RadMan 2XT, ICNIRP 1998 / Occupational <sup>1) 2)</sup>	2281/101
RadMan 2XT, FCC 96-326 / Occupational	2281/102
RadMan 2XT, SC 6 (2015) / Controlled	2281/103
RadMan 2XT, ICNIRP 1998 / General Public, E-Field <sup>2)</sup>	2281/111
<b>RadMan 2XT – personal monitor sets 60 GHz with adjustable alarm thresholds</b>	
RadMan 2XT Optioned, ICNIRP 1998 / Occupational <sup>1) 2)</sup>	2281/101-1
RadMan 2XT Optioned, FCC 96-326 / Occupational	2281/102-1
RadMan 2XT Optioned, SC 6 (2015) / Controlled	2281/103-1

1) The ICNIRP Occupational models satisfy the requirements of numerous national and international standards and ordinances such as Directive 2013/35/EU, EMFV 2016 (Germany) and VEMF 2016 (Austria).

2) Compliant with ICNIRP 2020 for frequencies above 27 MHz.

The scope of supply of a set comprises:

- RadMan 2 Basic Unit
- USB 2.0 cable
- Mounting adapter
- Carrying case
- Lanyard with carabiner
- Allen wrench 1.5 mm
- Fastening strap
- Operating manual, English



## 12.2 Optional accessories

Description	Part no.
Tripod, benchtop, 0.16 m, non-conductive	2244/90.32
Handle, non-conductive extension, 0.42 m	2250/92.02
Belt bag for RadMan	2250/92.06
Car charger adapter, USB 5 V	2259/92.20
Power supply (Europe), USB 5 V	2259/92.21
Power supply (USA), USB 5 V	2259/92.22
Power supply (UK), USB 5 V	2259/92.23





# 13 RadMan 2LT quick reference guide



	Monitor operating mode
Switch on the device	⇒ Press  > 1 s.
Switch off the device	⇒ Press  > 2 s.
Applications	The monitor is worn on the body and warns of electromagnetic radiation.
Integration time	1 s
Frequency range	Up to 8 GHz
Field exposure display	5 – 200%, illuminated individual red LED indicates measurement value for E- or H-field (whichever is higher)
Alarm threshold 1 50% exposure and higher	<ul style="list-style-type: none"><li>• Alarm LED flashes slowly</li><li>• Alarm signal sounds slowly</li><li>• Slow vibration</li></ul>
Alarm threshold 2 100% exposure and higher	<ul style="list-style-type: none"><li>• Alarm LED flashes rapidly</li><li>• Alarm signal sounds rapidly</li><li>• Fast vibration</li></ul>

## Display of the maximum exposure that has occurred since the last time the device was switched on:

⇒ Press  1x.



↳ Display returns to the Monitor operating mode after 5 s.

## Display of the battery capacity :

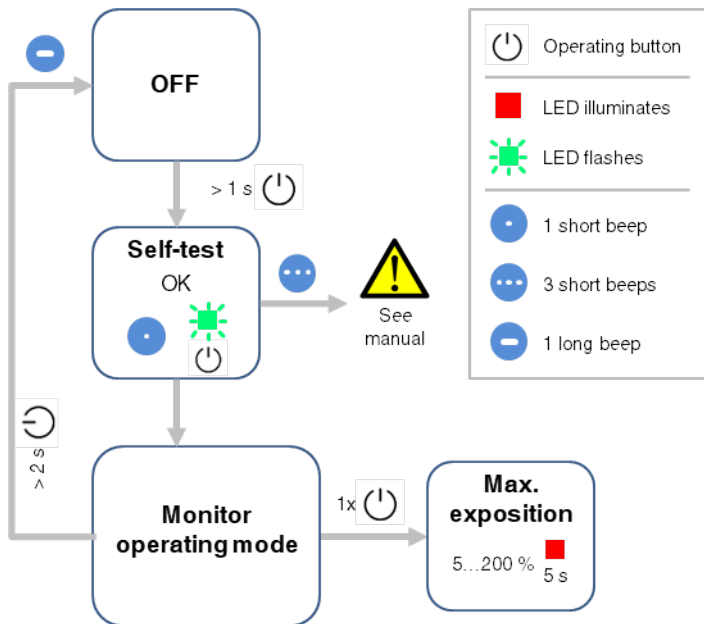
-  Power supply/charge mode via USB
-  Batteries are fully charged (800 h operating time with one battery charge)
-  Remaining operating time in battery mode < 5%



# 14 RadMan 2XT quick reference guide



	Monitor operating mode	RF Detection operating mode
<b>Switch on the device</b>	⇒ Press  > 1 s. ↳ Device is in the Monitor operating mode.	
<b>Changing the operating mode</b>	⇒ Press  2x. ↳ The operating mode switches between RF Detection and Monitor.	
<b>Switch off the device</b>	⇒ Press  > 2 s.	
<b>Applications</b>	The monitor is worn on the body and warns of electromagnetic radiation.	<ul style="list-style-type: none"> <li>Leakage search on waveguides</li> <li>Check to determine whether antennas are actually switched off</li> </ul>
<b>Integration time</b>	<ul style="list-style-type: none"> <li>1 s (pulse LED off)</li> <li>30 ms (pulse LED illuminates red)</li> </ul>	<ul style="list-style-type: none"> <li>30 ms (pulse LED illuminates red)</li> </ul>
<b>Frequency range</b>	Up to 60 GHz	
<b>Field exposure display</b>	<ul style="list-style-type: none"> <li>5 – 200%, illuminated individual red LED indicates measurement value for E- or H-field (whichever is higher)</li> </ul>	<ul style="list-style-type: none"> <li>5 – 200%, red LEDs as bar display</li> <li>Acoustic signal above 5%, sound becomes higher with increasing value</li> </ul>
<b>Alarm threshold 1</b> 50% exposure and higher	<ul style="list-style-type: none"> <li>Alarm LED flashes slowly</li> <li>Alarm signal sounds slowly</li> <li>Slow vibration</li> </ul>	<ul style="list-style-type: none"> <li>Alarm LED flashes slowly</li> <li>Slow vibration</li> </ul>
<b>Alarm threshold 2</b> 100% exposure and higher	<ul style="list-style-type: none"> <li>Alarm LED flashes rapidly</li> <li>Alarm signal sounds rapidly</li> <li>Fast vibration</li> </ul>	<ul style="list-style-type: none"> <li>Alarm LED flashes rapidly</li> <li>Fast vibration</li> </ul>

## Display of the maximum exposure that has occurred since the last time the device was switched on:

⇒ Press  1x.

↳ Display returns to the previously used mode after 5 s.

## Display of the battery capacity :

-  Power supply/charge mode via USB
-  Batteries are fully charged (800 h operating time with one battery charge)
-  Remaining operating time in battery mode < 5%

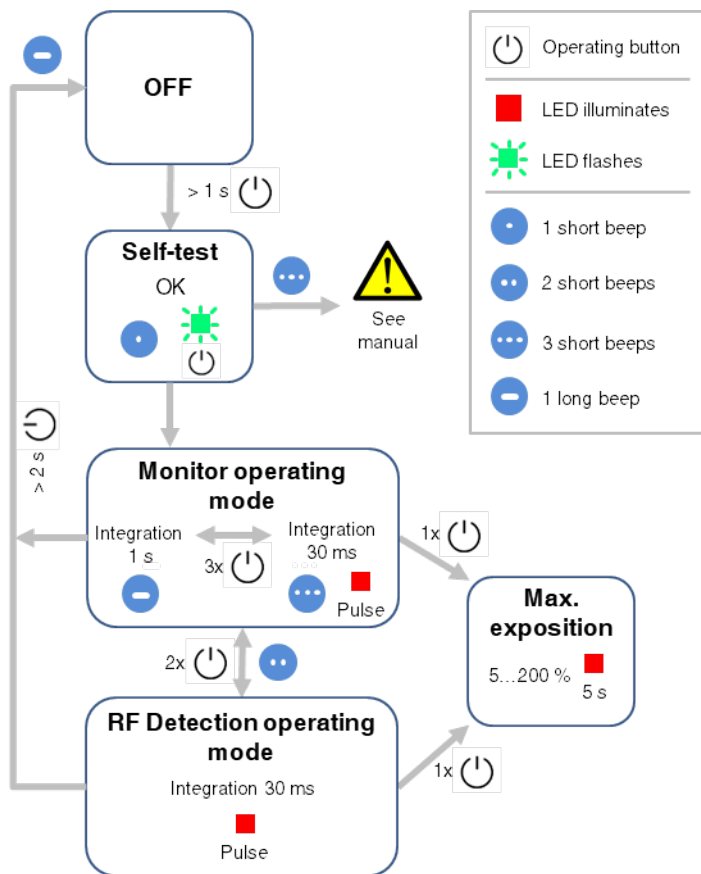

## **Narda Safety Test Solutions GmbH**

Sandwiesenstrasse 7  
72793 Pfullingen, Germany  
Phone +49 7121 97 32 0  
info@narda-sts.com

## **Narda Safety Test Solutions**

North America Representative Office  
435 Moreland Road  
Hauppauge, NY11788, USA  
Phone +1 631 231 1700  
info@narda-sts.com

## **Narda Safety Test Solutions S.r.l.**

Via Rimini, 22  
20142 Milano, Italy  
Phone +39 0258188 1  
nardait.support@narda-sts.it

## **Narda Safety Test Solutions GmbH**

Beijing Representative Office  
Xiyuan Hotel, No. 1 Sanlihe Road, Haidian  
100044 Beijing, China  
Phone +86 10 6830 5870  
support@narda-sts.cn

**[www.narda-sts.com](http://www.narda-sts.com)**