

ELT-400 Exposure Level Tester

Operating Manual

2300/98.11



NEED HELP?



SCAN OR CLICK HERE
TO CONTACT US



Air-Met Scientific
www.airmet.com.au

ELT-400
Exposure Level Tester

2304/xx, Series A ...

Operating Manual

This product is protected by the
following patents:
DE10000706 (C2)
JP2001235496

Narda Safety Test Solutions GmbH
Sandwiesenstr. 7, 72793 Pfullingen,
Germany
© 2022

Order no.: 2300/98.11
Edition: 11/01.2022, A ...
Previous Edition: 10/17.06, A ...

Subject to change
Our normal guarantee and delivery
terms apply
Printed in Germany

® Names and Logo are registered
trademarks of Narda Safety Test
Solutions GmbH - Trade names are
trademarks of the owners.

Contents

1	Introduction	1-1
1.1	About this instrument	1-1
1.1.1	Application	1-1
1.1.2	About this manual	1-3
2	Safety instructions	2-1
2.1	Using this operating manual	2-2
2.2	Before connecting up	2-2
2.3	Proper use	2-2
2.4	Improper use	2-2
2.5	General hazards	2-3
2.6	Dangers due to electromagnetic fields	2-5
2.7	AC adapter / charger unit	2-6
2.8	Rechargeable batteries	2-7
2.9	Faults and excessive stresses	2-8
2.10	Disposal in accordance with local regulations	2-8
2.10.1	Disposal of used equipment	2-8
2.10.2	Disposal of removable batteries	2-8
2.10.3	Disposal of permanently installed batteries	2-8
2.10.4	Deleting private data	2-8
3	Preparation for use	3-1
3.1	Unpacking	3-1
3.1.1	Packaging	3-1
3.1.2	Checking the package contents	3-1
3.1.3	Checking for transport damage	3-1
3.1.4	Recovery after storage and transport	3-1
3.2	Power supply	3-2
3.2.1	Charging the rechargeable batteries	3-3

3.3	Preparing for field measurements	3-4
3.3.1	Test setup	3-4
3.3.2	Connecting / disconnecting the B field probe	3-4
4	Control and display elements	4-1
4.1	Keypad	4-1
4.2	LCD display	4-3
4.2.1	LCD display elements	4-3
4.2.2	Display backlight	4-5
4.3	External connectors	4-6
5	Operation and use	5-1
5.1	Operating modes	5-1
5.1.1	Exposure STD (Shaped Time Domain)	5-2
5.1.2	Field strength	5-3
5.2	Example applications	5-4
5.3	Measuring.	5-6
5.3.1	Switching the ELT-400 on and off.	5-6
5.3.2	Selecting the operating mode (MODE)	5-8
5.3.3	Selecting the detection mode (DETECT)	5-9
5.3.4	Selecting the lower frequency range limit (LOW CUT)	5-10
5.3.5	Selecting the measurement range (RANGE)	5-10
5.3.6	Activating the MAX HOLD display function	5-11
5.3.7	Interpreting the measurement results.	5-12
5.4	Active probe (using the three-channel analog output).	5-14

6	Maintenance and repairs	6-1
6.1	Rechargeable and alkaline batteries	6-1
6.1.1	Replacing the rechargeable batteries and alkaline batteries	6-1
6.1.2	Disposal of alkaline and rechargeable batteries	6-2
6.2	Cleaning	6-2
6.3	AC adapter / charger unit	6-2
7	Remote control	7-1
7.1	Setting up the data link	7-1
7.1.1	Data cable	7-1
7.1.2	Interface parameters	7-2
7.2	Remote control basics	7-3
7.2.1	Overview of remote control commands	7-3
7.2.2	Remote control command format	7-5
7.2.3	Response value formats	7-6
7.3	Remote control commands	7-7
8	Specifications	8-1
8.1	Functional principle	8-1
8.2	Specifications when using the 100 cm ² probe	8-2
8.3	Specifications when using the 3 cm ² probe	8-6
8.4	Climatic environmental conditions	8-9
8.5	Declaration of origin	8-9
8.6	Declaration of conformity	8-10
8.7	Ordering information	8-11
8.8	Accessories (optional)	8-12

Annex A: Default values	A-1
Annex B: Exposure STD mode	B-1
Annex C: Instrument function	C-1
Annex D: Probe configuration / signal output	D-1
Annex E: Overview of instrument connections	E-1
Index of key words	

1 Introduction

1.1 About this instrument

1.1.1 Application

Magnetic fields are present in production areas, public places and the everyday environment. Measurements are often made in these areas to ensure that people are not exposed to fields that could cause injuries.

Global efforts to provide effective protection have resulted in a range of national and international guidelines and standards in recent years, which specify reference limit values for field strengths for various frequency ranges and signal shapes.

In practice, simple equipment must be used to determine the fields that occur and to check that the limit values are not exceeded.

The ELT-400 is a magnetic radiation exposure tester for the workplace and public areas. It was developed specially for the above areas, for use by industry health and safety representatives, insurers, and service providers.

Production areas

The ELT-400 is particularly suitable for applications involving production plant, including welding, smelting and heating, as well as most magnetic stirring equipment. It can handle special requirements such as the pulsed signals or phase control encountered in resistance welding without problems. However, the limit values for extremes of field strength and temperature must not be exceeded in such situations (Sec. 2.3, Sec. 8).

Everyday environment

Magnetic fields occur everywhere in the everyday environment, being produced by everything from power supply plant through to medical equipment.

For example, the electromagnetic and magneto-acoustic security systems used in department stores also operate within the frequency range of the ELT-400.

EMC test laboratory

The ELT-400 is ideal for investigating the magnetic fields produced by household equipment or other electrical devices. The reference test method described inter alia in the product standards EN 62233 and EN 62311 is implemented precisely in this instrument.

Instrument description

The ELT-400 is extremely easy to operate using just 6 buttons and can be used practically anywhere.

Exposure STD mode

Exposure STD mode is suitable for particularly simple and reliable measurements on all signal shapes (single or multiple frequency fields, pulsed fields).

The level of the magnetic field is displayed directly as a percentage of the reference limit value, regardless of the signal shape and frequency. The evaluation schemes specified by the relevant safety standards are implemented in the instrument.

The numerical result therefore clearly expresses the actual situation and indicates the available safety margin.

Field strength mode

The ELT-400 has a flat frequency response over a very wide frequency range. Detectors for RMS and peak value measurements can be used for broadband measurements. The results of field strength measurements are displayed in μT or mT .

Active probe

The ELT-400 can be connected to an oscilloscope or FFT analyzer for more in-depth analysis. The signal voltages from all three field probes (isotropic coil configuration) are output with proper phase. The amplified voltage can be input directly to the oscilloscope or FFT analyzer.

1.1.2 About this manual

Typographic conventions

Some special symbols are used in certain paragraphs to make it easier to read and understand this manual.

↪ This symbol indicates a **cross-reference** to another chapter, section or document.

Note: This indicates important additional information or **notes** concerning special features or situations

✓ This symbol indicates a **requirement** that must be fulfilled before the subsequent instructions are carried out.

⇒ This symbol indicates an **action** or task that must be performed.

1. A numbered list indicates a **sequence of actions** that must be performed one after the other.

2 Safety instructions

The following warnings, symbols and terms are used in this document in compliance with the American National Standard ANSI Z535.6-2006:

	This general danger symbol in conjunction with the terms CAUTION , WARNING or DANGER warns of the risk of severe injury. Follow all subsequent instructions to avoid injury or death.
NOTICE	Indicates a danger that could lead to damage or destruction of the device.
CAUTION	Indicates a danger that represents a low or medium risk of injury.
WARNING	Indicates a danger that could lead to death or severe injury.
DANGER	Indicates a danger that will result in death or severe injury.

Warning format

All Warnings have the following format:

 WARNING TERM
Type and source of danger Consequences of ignoring the warning ⇒ Action needed to avoid danger

2.1 Using this operating manual

- ⇒ Please read this manual carefully and completely before using the device.
- ⇒ Keep this manual so that it is readily available to all users of the device.
- ⇒ Always make sure that this manual accompanies the device if it is given to a third party.

2.2 Before connecting up

This instrument was shipped in perfect condition. Please follow the instructions below to ensure that this condition is maintained and that operation remains safe.

2.3 Proper use

The device may only be used under the conditions and for the purpose for which it was constructed.

The ELT-400 is designed for measuring and evaluating magnetic fields.

- ⇒ Only use the device under the conditions and for the purpose for which it was constructed.

Proper use also includes the following:

- ⇒ Following the national accident prevention rules that apply at the place of use.
- ⇒ Only allowing appropriately qualified and trained persons to use the device.

2.4 Improper use

The ELT-400 is **not** a warning device that gives indication of the presence of dangerous fields by means of visible or audible signals.

- ⇒ Always consider the device as a measuring device, never as a warning device.
- ⇒ Always carefully observe the actual measurement value display when approaching unknown fields.
- ⇒ In case of doubt, use an additional warning device for RF fields such as **RadMan (XT)** or **Nardalert** from Narda Safety Test Solutions.

2.5 General hazards

NOTICE

Destruction

Heat induced by radiation during industrial processes can cause the temperature of the instrument and the probe head in particular to increase beyond the permitted limit, even if the ambient air temperature is within the operating temperature range.

⇒ Check if heating is occurring and if necessary only use the instrument very briefly or with regular cooling off periods in such situations.

WARNING

Electric shock

High voltages may occur within the device.

- ⇒ Do not bring the measuring device or the antenna into contact with any electrically conductive items.
- ⇒ Do not open the device. (Opening the device will void any claim under warranty.)
- ⇒ Do not handle or use a device that is opened or that is visibly damaged.
- ⇒ Only use the accessories supplied with and designed for the ELT-400.

NOTICE

Malfunction

Improper use, damage, and unauthorized repairs can impair the accuracy and function of the device

- ⇒ Only use the device under the conditions and for the purpose for which it was constructed.
- ⇒ Regularly check the device for signs of damage.
- ⇒ Only allow qualified persons to make repairs.

Metallic stickers in the (yellow) sensor area of the probe can lead to measurement errors, specifically to an underestimation of the magnetic field strength.

- ⇒ Only apply stickers of any kind to the (black) shaft of the probe.

2.6 Dangers due to electromagnetic fields

WARNING

Strong fields

Very strong fields can occur in the vicinity of some radiation sources

- ⇒ Be aware of and observe any safety barriers and markings.
- ⇒ In particular, persons fitted with electronic implants (e.g. pacemakers) must keep away from dangerous areas.

WARNING

Unsuitable frequency range

Dangerous fields may not be detected if an unsuitable frequency range is selected

- ⇒ Always select the largest available or the most suitable frequency range.
- ⇒ Always carefully observe the actual measurement value display when approaching unknown fields.
- ⇒ In case of doubt, use an additional warning device for RF fields such as **RadMan (XT)** or **Nardalert** from Narda Safety Test Solutions.

NOTICE

Destruction

Extreme field strengths can cause damage to the sensor (see Specifications, Sec. 8).

- ⇒ Remove the instrument from the vicinity of the field source immediately in such situations.

2.7 AC adapter / charger unit

WARNING

Electric shock

Parts carrying dangerous voltages may be exposed and cause injury through electric shock if the AC adapter / charger is damaged.

⇒ Do not use an AC adapter / charger that is damaged.

NOTICE

Destruction of the AC adapter / charger

The AC adapter / charger can be destroyed by an incorrect AC line voltage, condensation, temperatures that are too high or too low, and insufficient ventilation.

- ⇒ Make sure that the AC line voltage is the same as the operating voltage of the AC adapter / charger **before** you connect it up.
- ⇒ Do not use the AC adapter charger if condensation has formed on it. If condensation is unavoidable, e.g. when the AC adapter charger is cold and is brought into a warm room, it must be allowed to dry out before you connect it up.
- ⇒ Only use the AC adapter / charger indoors and at temperatures between 0 °C and +40 °C.

2.8 Rechargeable batteries

The ELT-400 is fitted with rechargeable NiMH batteries to allow portable operation.

CAUTION

Explosion

Dry batteries can explode if you attempt to recharge them.

⇒ Before recharging, make sure that rechargeable batteries and not alkaline batteries are fitted in the battery compartment.

NOTICE

Destruction of the instrument

The instrument may be damaged if the batteries are inserted incorrectly.

⇒ Before recharging, make sure they are inserted correctly according to the polarity markings inside the battery compartment.

Disposal

Batteries are classed as hazardous waste.

Batteries must be disposed of through an approved return for disposal system. They must never be thrown away in the normal trash. Please refer to Sec. 2.10, Page 2-8.

2.9 Faults and excessive stresses

Take the unit out of service and secure it against unintentional operation if safe operation is no longer possible. This will be the case, for example, if:

- the instrument shows visible signs of damage
- the instrument does not work
- the instrument has been subjected to any kind of stress that exceeds the permitted limits.

Contact your local Service Center in such cases.

2.10 Disposal in accordance with local regulations

2.10.1 Disposal of used equipment



The crossed-out wheeled garbage can symbol indicates that this product is subject to the European WEEE Directive 2012/19/EU on the disposal of waste electrical and electronic equipment and must be disposed of separately from household waste in accordance with your national regulations.

In the European Union, all electronic measuring systems purchased from Narda after August 13, 2005 can be returned at the end of their useful life.

⇒ For more information, please contact your Narda distributor.

2.10.2 Disposal of removable batteries

- ⇒ Batteries must not be disposed of in household waste, but must be disposed of separately from the product in accordance with the applicable regulations. They can be returned free of charge to the appropriate collection points, your dealer or directly via Narda.
- ⇒ Please discharge the batteries before disposal.

2.10.3 Disposal of permanently installed batteries

There are no permanently installed batteries in this device.

2.10.4 Deleting private data

- ⇒ Make sure that you delete any stored private data before passing on or disposing of the device.

3 Preparation for use

3.1 Unpacking

3.1.1 Packaging

The packaging is designed to be re-used as long as it has not been damaged during previous transport. Please therefore keep the original packaging and use it whenever you want to transport the instrument in future.

3.1.2 Checking the package contents

↳ Package contents: see Ordering information, page 8-11

3.1.3 Checking for transport damage

Check the instrument and all accessories for transport damage after you have unpacked them. Such damage is most likely if the packaging itself has been clearly damaged. Do not attempt to use an instrument that has been damaged.

3.1.4 Recovery after storage and transport

Condensation may form on an instrument that has been stored or transported at a low temperature when it is brought into a warm room. To prevent damage, wait until all the condensation has evaporated from the surface of the instrument before using it. The instrument must not be used until it has reached a temperature that is within the guaranteed operating range of -10 to +50 °C.

3.2 Power supply

The ELT-400 is designed to be powered from alkaline or rechargeable batteries. The AC adapter / charger unit can also be used to provide power.

Note: The measurement characteristics of the ELT-400 may be affected by the effect of the cable on the field when the instrument is powered from the AC adapter / charger unit.

Operation from rechargeable batteries

The ELT-400 is powered from four 1.2 V NiMH batteries (Mignon, size AA, IEC R 6).

The operating time from a set of fully charged batteries is about twelve hours.

Note: The batteries are supplied pre-charged. Several charge / discharge cycles will be needed in order to achieve their full capacity.

Handling rechargeable batteries

- Always handle rechargeable batteries with care.
- Avoid incorrect polarity.
- Do not short-circuit the battery contacts.
- If possible, leave the ELT-400 connected to the AC adapter / charger unit to ensure that it is always ready for use.
- Do not leave discharged batteries in the instrument for a long period of time.

↳ Charging the rechargeable batteries: see page 3-3

Operation from alkaline batteries

Four 1.5 V alkaline batteries (Mignon, Size AA, IEC LR 6) can be used in the ELT-400 instead of rechargeable batteries.

The operating time from alkaline batteries is about 20 hours.

↳ Replacing the rechargeable batteries and alkaline batteries: see page 6-1

3.2.1 Charging the rechargeable batteries

Complete recharging takes less than 2 hours.

Caution: Alkaline batteries can explode if you attempt to recharge them. See Safety instructions, Sec. 2.8, Page 2-7.

Starting the charging cycle

- ✓ The AC line voltage matches the operating voltage of the AC adapter / charger unit.
 - ✓ The appropriate AC line adapter has been fitted.
1. Connect the AC adapter / charger unit to the “Charge” socket of the ELT-400 (see Annex E, Fig. E-1).
 2. Connect the AC adapter / charger unit to the AC line supply.
 - The charge cycle starts.
At least one of the four segments in the battery symbol in the LCD is filled and flashes. Eventually all the segments will be filled as charging proceeds.
 - When the batteries are fully charged, the AC adapter / charger unit switches to trickle charge mode automatically.
All the segments of the battery symbol in the LCD are filled and displayed.

Note: The charge cycle is still indicated if the AC adapter / charger unit is disconnected from the AC line after charging has started but remains connected to the ELT-400. If charging seems to be taking an unusually long time, check that the connection to the AC line supply is working properly.

3.3 Preparing for field measurements

3.3.1 Test setup

The following are part of the complete test setup for measuring a field:

- The basic instrument
- The B field probe, cross sectional area 100 cm^2
or cross sectional area 3 cm^2 (option)
- Extension cable for connecting probe to tester if needed (option)

The instrument uses an external isotropic magnetic field probe and is also suitable for standards-compliant measurements in non-homogeneous fields.

Note: Persons or objects should not come between the probe and the radiation source during the measurement.

3.3.2 Connecting / disconnecting the B field probe

The multi-pin connector socket for the B field probe is located at the top of the ELT-400. The field probe is secured by means of a sliding locking sleeve.

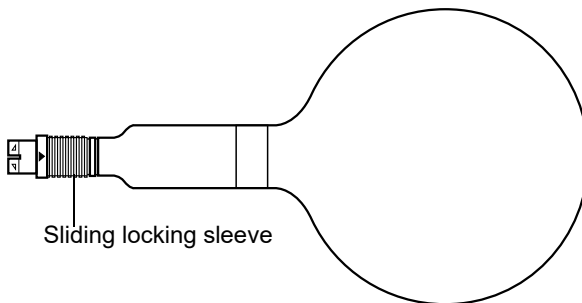

Fig. 3-1 B field probe with 100 cm^2 cross-sectional area
The 3 cm^2 B field probe (optional) uses the same locking mechanism.

Connecting the field probe directly

1. Place the probe on the basic instrument so that the red marks on the plug and socket point in the same direction.
2. Hold the field probe by the black shaft and press it into the basic instrument until the locking sleeve clicks into place.
The instrument detects the probe automatically.

Disconnecting the field probe

⇒ Hold the field probe by the locking sleeve and pull it off the basic instrument.

Connecting the field probe using the extension cable

The extension cable is fitted with the same plugs and sockets as the probes and the basic instrument. Use the locking mechanism in the same way as when connecting the probe directly.

4 Control and display elements

The instrument diagram in the Annex shows the positions of all control and display elements.

4.1 Keypad



Key	Function
	ON/OFF On / off key <ul style="list-style-type: none">• Starts the instrument with its default settings.• Switches the display backlight on or off (press briefly).• Switches the instrument off (press for a longer time).
	MAX HOLD Display mode selection key <ul style="list-style-type: none">• Switches the MAX HOLD display mode on or off.• Activation of the MAX HOLD function is shown as "Max" in the display.
	RANGE Measurement range selection key <ul style="list-style-type: none">• Switches between HIGH and LOW ranges.• Selection of the HIGH setting is shown in the display.• In LOW range setting the instrument is 10 times more sensitive. Measurement range and overload limit are also reduced by a factor of 10.

Table 4-1 Keypad overview



Key	Function
	<p>MODE</p> <p>Operating mode selection key</p> <ul style="list-style-type: none"> • Switches between “Exposure STD” and “Field strength” modes. • Switches between standardized evaluation schemes and measurement ranges. • All evaluation schemes and measurement ranges implemented in the instrument are shown beneath the display. The selected setting is indicated by the arrow symbol in the display.
	<p>DETECT</p> <p>Detection mode selection key</p> <ul style="list-style-type: none"> • Switches between RMS, PEAK and STND (Standard) detection modes. • The selected setting is shown in the display.
	<p>LOW CUT</p> <p>Lower frequency range limit selection key</p> <ul style="list-style-type: none"> • Switches the lower frequency range limit between 1 Hz, 10 Hz and 30 Hz. • The selected setting is shown in the display.

Table 4-1 Keypad overview

4.2 LCD display

4.2.1 LCD display elements

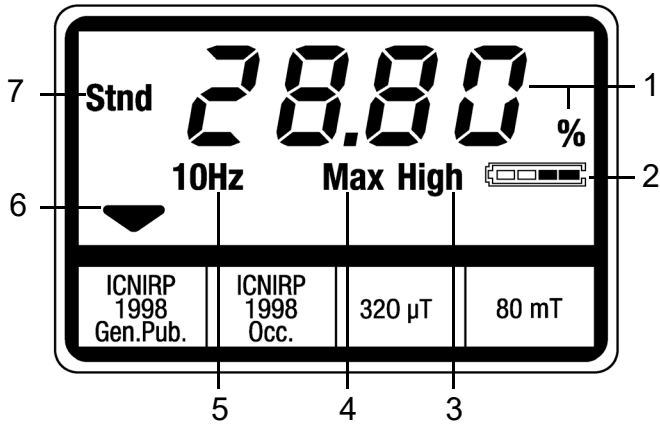

Fig. 4-1 LCD elements (example)

No.	Function
1	Measured value including units The units depend on the selected measurement mode <ul style="list-style-type: none"> • % • μT, mT

Table 4-2 LCD display elements

No.	Function
2	<p>Battery symbol consisting of a frame containing four segments. Indicates the current charge status of the rechargeable batteries.</p> <p>In operation</p> <ul style="list-style-type: none"> • Outer frame displayed. • Inner segments displayed to indicate the charge level. <p>Batteries discharged</p> <ul style="list-style-type: none"> • Outer frame flashes. • All inner segments off. • To avoid deep discharge, the ELT-400 switches off automatically after about 15 minutes. <p>Batteries fully discharged or not fitted</p> <ul style="list-style-type: none"> • The battery symbol is no longer displayed at all. <p>Charging (with AC adapter / charger unit connected)</p> <ul style="list-style-type: none"> • Outer frame displayed. • Inner segments flash to indicate the charge level. <p>Trickle charging (with AC adapter / charger unit connected)</p> <ul style="list-style-type: none"> • Outer frame displayed. • All inner segments displayed. <p>Note: The charge state is only indicated correctly for rechargeable batteries that have been charged directly in the instrument.</p>
3	<p>Selected measurement range:</p> <ul style="list-style-type: none"> • HIGH • No display = LOW
4	<p>Selected display function:</p> <ul style="list-style-type: none"> • MAX = MAX HOLD activated • No display = MAX HOLD deactivated

Table 4-2 LCD display elements

No.	Function
5	Display of selected lower frequency range limit: <ul style="list-style-type: none"> • 1 Hz • 10 Hz • 30 Hz
6	Selected operating mode indicated by arrow symbol.
7	Display of selected detection mode: <ul style="list-style-type: none"> • RMS = root mean square value. • Stnd = automatic selection according to exposure evaluation schemes. • Peak = peak value.

Table 4-2 LCD display elements

4.2.2 Display backlight

Switching on the display backlight

⇒ With the instrument switched on, press the **ON/OFF** key briefly.
The display backlight switches on.

Switching off the display backlight

⇒ Press the **ON/OFF** key briefly.
The display backlight switches off.

Note: The operating time of the instrument is reduced when the display backlight is switched on, as additional current is used. To conserve battery power, the display backlight switches off automatically after about 10 minutes.

4.3 External connectors

There are three connector sockets for external equipment on the left side of the instrument.



Socket	Function
 <p>RS-232</p>	Serial data interface Computer (PC) connection <ul style="list-style-type: none"> • 19200 baud • 8-N-1 • Handshake XON/XOFF • For pin connections (see Fig. 7-1)
 <p>Scope</p>	Analog signal output (active probe) Connection to oscilloscope or analyzer <ul style="list-style-type: none"> • Three channels (X-Y-Z) • Interface cable: D-SUB15 / 3 x BNC
 <p>Charge</p>	AC adapter / charger unit connector <ul style="list-style-type: none"> • Nominal voltage: 9 V

Table 4-3 External connectors

5 Operation and use

5.1 Operating modes

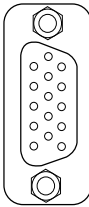
Direct numerical display of:

- Safety margin compared with the exposure limit values specified in standards (“Exposure STD” mode)
- Field strength (“Field strength” mode)
- Also for analysis using an oscilloscope or FFT analyzer (Active Probe).

Exposure STD mode

In “Exposure STD” mode, the level of the magnetic field (B field) is displayed directly as a percentage of the reference value, regardless of signal shape and frequency. The user simply selects the desired standard. Internal filters are used to emulate the required frequency response for the limit values (Attenuation characteristics of filters used in ELT-400: see page B-5).

Advantages of the ELT-400:

- Instant display of current situation and safety margin without needing to refer to the standards.
- Automatic allowance for various signal shapes as well as for pulsed fields without need for in-depth knowledge of the field, the instrument or the device under test.
- Continuous monitoring of the field with any change being evaluated immediately.
- Default setting takes RMS and peak values into account simultaneously. The appropriate detector is selected continuously and automatically, depending on the test signal and the selected standard. The detectors can also be selected independently to provide more information about the signal.

Field strength mode

“Field strength” mode is useful if the field to be measured only contains a relevant frequency component. The result is displayed in mT or μT .

5.1.1 Exposure STD (Shaped Time Domain)

Broadband measurement with simultaneous real-time exposure assessment

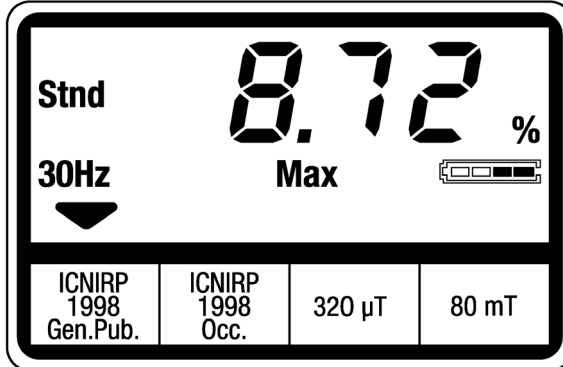

Fig. 5-1 Measurement display in "Exposure STD" mode

- Measurement goal:** Rapid, reliable assessment of field exposure with reference limits from a selected standard.
- Measured quantity:** Field exposure.
- Display:** Numerical display of measurement result as a percentage of the field strength limit value.
- Special features:** Different evaluation schemes (reference value curves, exposure ranges) available depending on instrument version.
- Active probe:** A frequency response weighted signal is available.

5.1.2 Field strength

Broadband real time measurement of magnetic flux density

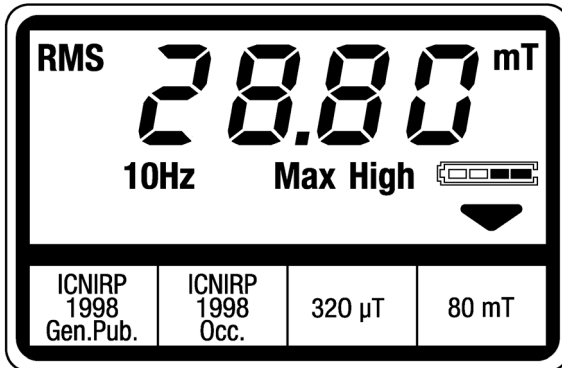

Fig. 5-2 Measurement display in “Field strength” mode

Measurement goal: Measurement of overall field strength.

Measured quantity: RMS or peak flux density value.

Display: Numerical display of measurement result in units of mT or μ T.

Special features: Flat frequency response

Active probe: The output field is available independent of frequency.

5.2 Example applications

To take advantage of the full performance of the ELT-400, it is important to optimize the instrument settings to match the expected characteristics of the field being investigated. The table below provides assistance for this important task. It shows typical applications together with the appropriate instrument settings. Please note, though, that the choice of measurement range or the lower measurement range limit in particular must be decided according to the actual measurement situation and the aim of the measurement.

Application	Characteristic feature	Recommended instrument setting
Magnetic stirring	High field strengths, very low frequencies	<ul style="list-style-type: none"> • MODE: Exposure STD (Exp.1/ occ.) • RANGE: High • LOW CUT: 1 Hz
Household	Low field strength 50/60 Hz	<ul style="list-style-type: none"> • MODE: Field strength 320 μT • RANGE: Low • LOW CUT: 30 Hz • DETECT: RMS
Induction heating / melting	High field strength 50 Hz to 20 kHz	<ul style="list-style-type: none"> • MODE: Exposure STD (Exp.1/ occ.) • RANGE: High • LOW CUT: 30 Hz
Annealing / tempering	High field strength 10 kHz to 30 kHz	<ul style="list-style-type: none"> • MODE: Exposure STD (Exp.1/ occ.) • RANGE: High • LOW CUT: 30 Hz
Resistance welding, spot welding	50 Hz, pulsed)	<ul style="list-style-type: none"> • MODE: Exposure STD (Exp.1/ occ.) • RANGE: High • LOW CUT: 30 Hz
MF welding	Pulsed DC field with dominant component of converter frequency	<ul style="list-style-type: none"> • MODE: Exposure STD (Exp.1/ occ.) • RANGE: Low • LOW CUT: 1 Hz

Table 5-1 Example applications and instrument settings

Application	Characteristic feature	Recommended instrument setting
Electronic article surveillance (electromagnetic)	Complex pulse shape, 20 Hz to 10 kHz	<ul style="list-style-type: none"> • MODE: Exposure STD (gen. pub.) • RANGE: High • LOW CUT: 10 Hz
Electronic article surveillance (magneto-acoustic)	Complex pulse shape, 58 kHz	<ul style="list-style-type: none"> • MODE: Exposure STD (gen. pub.) • RANGE: Low • LOW CUT: 30 Hz
CE certification (household appliances)	Product standard w=1, take coupling factor into account if necessary	<ul style="list-style-type: none"> • MODE: EN 62233 • RANGE: Low • LOW CUT: 10 Hz

Table 5-1 Example applications and instrument settings

5.3 Measuring

5.3.1 Switching the ELT-400 on and off

Switching the ELT-400 on

- ✓ You have made sure of the power supply
- ⇒ Press the **ON/OFF** key briefly.
 - The basic instrument switches on.
 - The function test runs.

Function test

The function test checks the internal memory, display, signal processor and internal signal paths.

- During the function test,
 - all elements of the display and the display backlight are switched on for 0.5 seconds,
 - the firmware version is displayed for about 2 seconds.

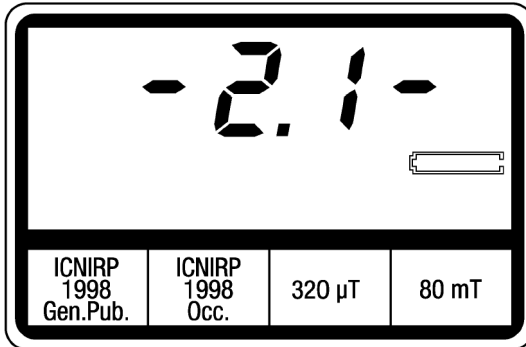

Fig. 5-3 Test display

When the function test is successfully completed,

- the measurement display appears.
- You can now start making measurements.



Fig. 5-4 Measurement display

Switching off the ELT-400

- ⇒ Press and hold down the **ON/OFF** key for about 3 seconds.
The basic instrument switches off.

Possible faults

No display after switch on

The rechargeable batteries or alkaline batteries are completely discharged.

- ⇒ Recharge the batteries or replace the alkaline batteries.
- ↪ Charging the rechargeable batteries: see page 3-3
- ↪ Replacing the rechargeable batteries and alkaline batteries: see page 6-1

One of the following error messages appears after switching on: F200, F210, F240, F250, F260, F280

An instrument error has occurred.

- ⇒ Make a note of the error message.
- ⇒ Contact the Service Center.

The display shows the error message “noPr”.

The probe is not connected or has not been detected by the instrument.

⇒ Remove the probe and reconnect it.

↪ Connecting / disconnecting the B field probe: see page 3-4

The display shows the error message “unPr”.

The unknown probe has been connected.

⇒ Connect the correct probe.

↪ Connecting / disconnecting the B field probe: see page 3-4

5.3.2 Selecting the operating mode (MODE)

The operating modes implemented in the instrument are shown below the display.

↪ Operating modes: see page 5-1

⇒ Press the **MODE** key until the arrow symbol in the display points to the required operating mode.

Note: The measurement display will fluctuate whenever the setting is changed. This fluctuation depends on the selected lower frequency range limit and may continue for several seconds, particularly if 1 Hz or 10 Hz is selected. Wait until the display has settled before starting measurements.

5.3.3 Selecting the detection mode (DETECT)

Three modes of detection are available depending on the selected operating mode:

↪ Detection mode / Detector: see page C-2

Detection mode	Field strength mode	Exposure STD mode
STND (Standard) The detection mode specified in the appropriate standard is set automatically. You can also select RMS and PEAK detection if required.		x
RMS (root mean square value) The RMS value resulting from the isotropic measurement is derived from the RMS values for the three individual measurement axes.	x	x
PEAK (peak value) The peak value of the isotropic measurement is derived from the peak value of the field vector. The phase in the three individual measurement axes is taken into account.	x	x

Table 5-2 Available detection modes, depending on the selected operating mode

⇒ Press the **DETECT** key until the required detection mode is shown in the display.

Note: The selected detection mode is applied immediately. The measurement value is valid as soon as the switch over occurs.

5.3.4 Selecting the lower frequency range limit (LOW CUT)

The default measurement range setting is 10 Hz to 400 kHz.

The lower frequency range limit can be extended to 1 Hz or reduced 30 Hz.

⇒ Press the **LOW CUT** key until the required value for the lower frequency range limit is shown in the display.

Note: The 1 Hz setting should only be selected when this is necessary for the measurement application (Operating modes: see page 5-1).

The effect of e.g. the earth's magnetic field is clearly discernible when the instrument is moved if one of these settings is made. A tripod can be used to prevent these effects.

Note: The measurement display will fluctuate whenever the setting is changed. This fluctuation depends on the selected lower frequency range limit and may continue for several seconds, particularly if 1 Hz or 10 Hz is selected. Wait until the display has settled before starting measurements.

5.3.5 Selecting the measurement range (RANGE)

The measurement range can be switched between HIGH and LOW settings depending on the measurement task. If small field strengths are to be measured, the accuracy of the measurement can be improved by selecting the LOW setting.

LOW: High measurement sensitivity with limited overload capacity.

HIGH: High overload capacity with limited measurement sensitivity.

⇒ Press the **RANGE** key until the required measurement range setting is made.

The display shows HIGH when HIGH range is selected.

– or –

HIGH is no longer shown in the display when LOW range is selected.

Note: The measurement display will fluctuate whenever the setting is changed. This fluctuation depends on the selected lower frequency range limit and may continue for several seconds, particularly if 1 Hz or 10 Hz is selected. Wait until the display has settled before starting measurements.

5.3.6 Activating the MAX HOLD display function

The default setting updates the current measurement values in the display continuously. Activating the MAX HOLD function causes the highest level measured since activation of the MAX HOLD function to be displayed. This considerably simplifies the measurement of fields that vary over time, and particularly of pulsed fields.

If required, the highest field strength existing within the volume of a room can also be displayed by moving the instrument around the room with the MAX HOLD display function activated.

Activating the MAX HOLD function

⇒ Press the **MAX HOLD** key until MAX appears in the display.

Deactivating the MAX HOLD function

⇒ Press the **MAX HOLD** key until MAX is no longer shown in the display. The current measurement value is now shown in the display.

5.3.7 Interpreting the measurement results

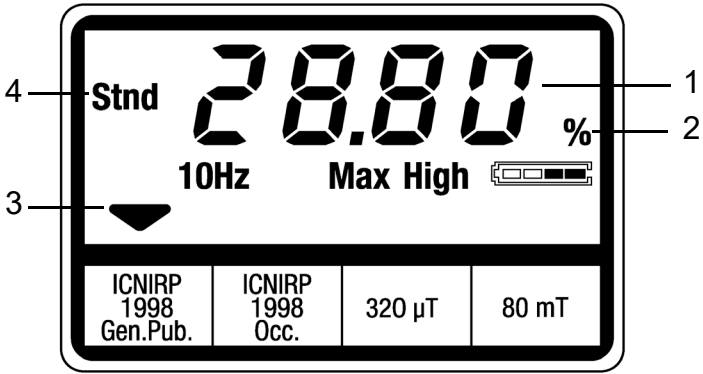

Fig. 5-5 Measurement display showing measurement result

No.	Explanation
1	<p>Numerical value of measurement result</p> <p>The following applies to “Exposure STD” mode: The percentage displayed refers to the limit value specified in the selected safety standard. A measured value of “100 %” indicates that the limit value has been reached, regardless of the frequency and signal shape.</p> <p>Caution: The results are calculated using standardized evaluation schemes in “Std” detection mode only.</p>
2	Measurement value units; depend on the selected operating mode.
3	<p>Operating mode</p> <ul style="list-style-type: none"> • The selected standard (standard’s name, exposure range) is displayed in “Exposure STD” mode. • The end value (RMS value) of the measurement range is displayed in Field strength mode.
4	<p>Detection mode used</p> <p>The crest factor (peak/RMS) can be calculated from the RMS and peak values. This gives the factor $\sqrt{2}$ for a pure sine wave signal (only).</p>

Possible faults:**The overload display appears**

Fig. 5-6 Overload display

Notice: Extreme field strengths can cause damage to the sensor (see Specifications, Sec. 8; Safety instructions, Sec. 2.6, Page 2-5)

Whatever the case, the selected measurement range is unsuitable for the measurement task.

1. Select HIGH range.
2. If the overload display is still shown, increase the distance of the ELT-400 from the field source.
 - ↳ Selecting the measurement range (RANGE): see page 5-10
- or –
3. Deactivate the MAX HOLD function if it is activated.
 - MAX HOLD cannot be reactivated until the overload display has cleared.
 - ↳ Activating the MAX HOLD display function: see page 5-11
 - ↳ Overload monitoring: see page C-6

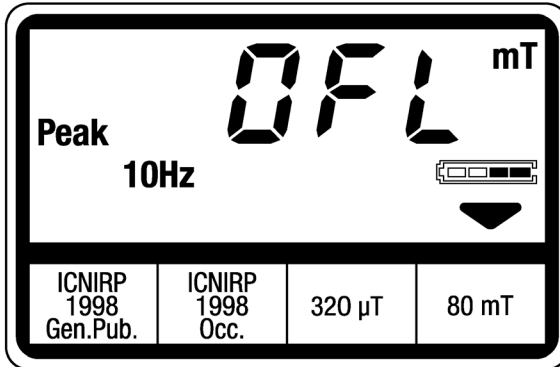
5.4 Active probe (using the three-channel analog output)

The signal detected by the field probe (measurement coils) can be displayed for scientific applications or further analysis of the signal shape and frequency. An oscilloscope or FFT analyzer can be connected to the analog signal output (Scope) of the ELT-400 for this purpose.

↪ External connectors: see page 4-6

The analog signal output provides the signal voltages for all three spatial axes with their correct phases and covers the entire bandwidth of the instrument. The output is also affected by the measurement range, operating mode and lower frequency range limit settings.

If the measurement is to be referred to the spatial axes, the probe must be aligned to correspond.

↪ Annex D: Probe configuration / signal output: see page D-1

The analog output can be used in both modes (Exposure STD and Field Strength).

The maximum output voltage of 800 mV RMS equals in each case the overload limit of the selected measurement range if a sinusoidal signal is applied. The load impedance must be equal to or higher than 10 kOhm.

Slight DC offsets can be present at the output. We recommend that you measure with the oscilloscope or spectrum analyzer in AC mode.

Note the following (depending on the measurement mode):

Field Strength mode

The output voltages at the X, Y and Z outputs correspond in each case to the measured field strength (magnitude and phase).

Exposure STD mode

The magnitude and phase of the output voltage vary relative to the field strength due to the transfer function in Exposure STD mode (the phase relationship between the three channels X, Y, Z is unaffected).

Example

Sinusoidal signal in range 10–500 Hz, measured in Exposure STD mode

- Analog output voltages on channels X, Y and Z are phase-shifted relative to the measured field strength by approx. 90° (due to the differentiating transfer function in Exposure STD mode).
- The output signal is the derivative vs. time of the field strength.

6 Maintenance and repairs

6.1 Rechargeable and alkaline batteries

6.1.1 Replacing the rechargeable batteries and alkaline batteries

- ✓ The ELT-400 is switched off
- ✓ The ELT-400 is disconnected from the AC adapter / charger unit

Changing the rechargeable or alkaline batteries

1. Remove the probe.
2. Starting from the lower side of the instrument, slide off the rubber cover.
3. Push down the locking button on the back of the instrument and remove the battery compartment lid.
The battery compartment is now accessible.
4. Insert the new alkaline or rechargeable batteries. Make sure that you insert them correctly (positive and negative poles are marked in the instrument).

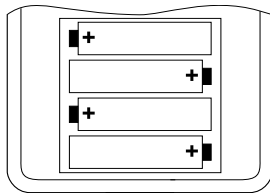

Fig. 6-1 Polarity markings in the instrument battery compartment

5. Replace the battery compartment lid and close it.
6. Starting from the top side of the instrument, slide the rubber cover back onto the instrument.
7. Plug in the probe.
The instrument is ready to use again.

Notice: The instrument may be damaged if the batteries are inserted incorrectly. See Safety instructions, Sec. 2.8, Page 2-7.

6.1.2 Disposal of alkaline and rechargeable batteries

The instrument contains NiMH batteries or alkaline batteries.

Note: Do not put rechargeable or alkaline batteries in household trash. Return them to the appropriate recycling center.

6.2 Cleaning

- Do not use solvents to clean the casing or probes of the ELT-400 or the AC adapter / charger unit. Use lukewarm water to which a little liquid detergent has been added.
- Only use a slightly damp cloth for cleaning. Never let water get into the instrument.
- To prevent drying marks and spots, use a dry cloth to polish the damp surfaces of the instrument.

6.3 AC adapter / charger unit

The AC adapter / charger unit is not designed to be repaired.

The entire unit should be replaced if defects or malfunctions occur.

7 Remote control

7.1 Setting up the data link

You will need a suitable cable for making the link between the ELT-400 and the measurement computer. It is available as an accessory.
(Order number 2260/90.51)

7.1.1 Data cable

DB9 plug:

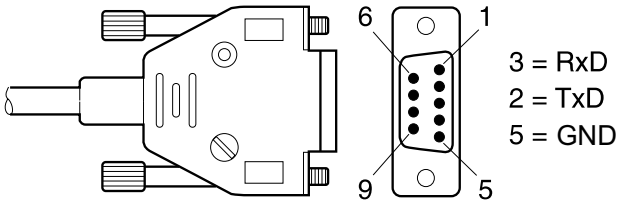

Fig. 7-1 DB9 plug connections

Jack plug:

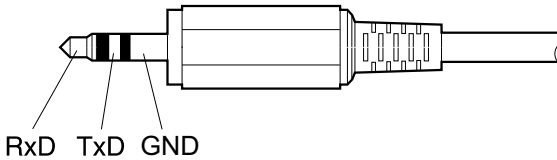

Fig. 7-2 Jack plug connections

Direction of data flow:

- RxD: Data from ELT-400
- TxD: Data to ELT-400

Connecting the instrument to the measurement computer

1. Plug the jack plug into the "RS-232" socket on the ELT-400.
2. Plug the DB9 plug into the serial interface connector (COM) of the measurement computer.

7.1.2 Interface parameters

- ✓ The ELT-400 is connected to the PC.

The following parameters must be set for the serial interface of the computer:

- Baud rate: 19200
- 1 start bit
- 8 data bits
- No parity
- 1 stop bit
- Handshake: XON/XOFF

7.2 Remote control basics

All settings can be made and results read out by remote control instead of manual operation.

Note: The instrument parameters are set to defined default values if you switch the ELT-400 off and then on again before using it in remote control mode. This also applies to various other operating actions.

↪ Annex A: Default values

7.2.1 Overview of remote control commands

The ELT-400 runs through a test phase when you switch it on. This tests important settings and instrument configurations.

The following remote control commands can be used to query or change the instrument status:

Remote control command	
*IDN? [CR]<LF>	see page 7-19
SYST:BAT? [CR]<LF>	see page 7-19
SYST:DEFAULTS [CR]<LF>	see page 7-21
SYST:ERR? [CR]<LF>	see page 7-20
SYST:KLOCK [?][CR]<LF>	see page 7-16
SYST:XONXOFF [?]<SP><param>[CR]<LF>	see page 7-21

Table 7-1 Remote control commands for querying the instrument status

The ELT-400 is in the measurement phase as soon as the test phase has been completed successfully.

The following remote control commands can additionally be used in the measurement phase:

Remote control command	
CALC:BAT[?]<SP><param>[CR]<LF>	see page 7-17
CALC:OVLD[?]<SP><param>[CR]<LF>	see page 7-18
GET:MODE_INFO[?]<SP><STD><name>[CR]<LF>	see page 7-8
MEAS[?][CR]<LF>	see page 7-14
SEN:TYPE?[CR]<LF>	see page 7-7
SET:DETECTOR[?]<SP><param>[CR]<LF>	see page 7-9
SET:LOW_CUT[?]<SP><param>[CR]<LF>	see page 7-10
SET:MAX_HOLD[?]<SP><param>[CR]<LF>	see page 7-11
SET:MODE[?]<SP><param>[CR]<LF>	see page 7-12
SET:RANGE[?]<SP><param>[CR]<LF>	see page 7-13

Table 7-2 Remote control commands in the measurement phase

7.2.2 Remote control command format

The following conventions are used to describe the remote control commands:

Character	Meaning
?	Instrument parameter / measurement value query
param	Instrument status transfer parameter
[]	Optional information is given in square [brackets]
< >	Mandatory information is given in pointed <brackets>
SP	Space; ASCII decimal character: 32
CR	Carriage Return; ASCII decimal character: 13
LF	Line Feed; decimal character: 10
/	Separates alternative entries

Table 7-3 Remote control command conventions

Note: The remote control commands do not distinguish between upper and lower case letters.

The remote control command will be ignored if the value of the transfer parameter **param** is outside the valid range.

To check the validity of remote control commands:

- ↪ Remote control command SYST:ERR?[CR]<LF>, see page 7-20

7.2.3 Response value formats

Different formats are used for the values returned as responses by the ELT-400.

Response strings are terminated with a "Carriage Return" and a "Line Feed".

It is a good idea to filter out and delete unnecessary characters before subjecting the received data to further processing. The following characters can be removed:

- Leading spaces (ASCII decimal character: 32)
- Carriage Return (ASCII decimal character: 13)
- Line Feed (ASCII decimal character: 10)
- DC1 (ASCII decimal character: 17)
- DC3 (ASCII decimal character: 19)

7.3 Remote control commands

All the remote control commands used for the ELT-400 are described in this section. The commands are sorted according to their meanings.

Field probe

SEN:TYPE?[CR]<LF>

Response:

<param><CR><LF>

Meaning:

Returns the type of field probe connected.

Response values:

param	Explanation
0	No probe connected
1 to 99	Probe type identification

Measured quantity, evaluation mode

GET:MODE_INFO?[CR]<LF>

Response:

<param>, <text><CR><LF>

Meaning:

Returns the operating mode that is selected.

param	Explanation
0	"Field strength" mode
1	"Exposure STD" mode

Table 7-4 Operating mode characterization

text	Explanation
	Additional information: <ul style="list-style-type: none"> • End value (RMS value) if param = 0 • Standard's name and exposure range if param = 1

Table 7-5 Additional information

Note: The length of <text> is limited to 30 characters.

SET:DETECTOR<SP><param>[CR]<LF>

SET:DETECTOR?[CR]<LF>

Response:

<param><CR><LF>

Meaning:

Selects the detection mode.

param	Explanation
RMS	The RMS value measured using the selected operating mode will be output.
PEAK	The peak value measured using the selected operating mode will be output.
STND	In "Exposure STD" mode only: The detection mode is selected automatically according to the selected standard.

Table 7-6 Detection mode selection settings

SET:LOW_CUT<SP><param>[CR]<LF>

SET:LOW_CUT?[CR]<LF>

Response:

<param><CR><LF>

Meaning:

Sets the lower frequency range limit.

param	Explanation
1	Defines 1 Hz as the lower frequency range limit.
10	Defines 10 Hz as the lower frequency range limit.
30	Defines 30 Hz as the lower frequency range limit.

Table 7-7 Lower frequency range limit settings

SET:MAX_HOLD<SP><param>[CR]<LF>

SET:MAX_HOLD?[CR]<LF>

Response:

<param><CR><LF>

Meaning:

Activates / deactivates the MAX HOLD display function.

param	Explanation
ON	Activate MAX HOLD display function <ul style="list-style-type: none"> • The highest value measured since the function was activated is output instead of the current measurement value. • The status of the overload display takes into account the instrument status since the function was activated. ↪ Remote control command CALC:OVLN?, see page 7-18
OFF	Deactivate MAX HOLD display function <ul style="list-style-type: none"> • The current measurement value is output instead of the highest measured value. • The function is deactivated automatically for particular actions. • Annex A: Default values: see page A-1

Table 7-8 Display function settings

SET:MODE<SP><param>[CR]<LF>

SET:MODE?[CR]<LF>

Response:

<param><CR><LF>

Meaning:

Selects the operating MODE. The operating modes are numbered consecutively (1 to 4). The mode assigned to each number depends on the instrument version.

param	Explanation
1	Displays the first operating mode counting from the left hand side of the display. ↳ LCD display elements, see page 4-3
2, 3, 4	Displays the second, third or fourth operating mode counting from the left hand side of the display.

Table 7-9 Operating mode settings

Note: The operating mode selected can also be queried as text information.

↳ Remote control command GET:MODE_INFO?, see page 7-8

SET:RANGE<SP><param>[CR]<LF>

SET:RANGE?[CR]<LF>

Response:

<param><CR><LF>

Meaning:

Sets the measurement range for the selected operating mode.

param	Explanation
LOW	Measurement range particularly suitable for low field strengths <ul style="list-style-type: none"> • High measurement sensitivity. • Reduced overload capacity.
HIGH	Measurement range suitable for higher field strengths <ul style="list-style-type: none"> • High overload capacity. • Reduced measurement sensitivity.

Table 7-10 Measurement range settings

MEAS

Meaning:

Transfers the measured values and, where appropriate, the status information.

Different modes for transferring individual values and for transferring values continuously are provided.

Remote control command	Explanation
MEAS? [CR]<LF>	Transfers the latest measured value / status on request. <ul style="list-style-type: none"> Asynchronous query: The same measured value is transferred several times if the query is made more often than the measurement value is updated (measured value is refreshed 4 times per second).
MEAS:ARRAY? <SP> < param >[CR]<LF>	Consecutive transfer of a selectable number of measured values / statuses at regular intervals (measured value is refreshed 4 times per second). <ul style="list-style-type: none"> Synchronous query: Each measured value is transferred once only. The transfer of the first measured value may be delayed slightly. param: Number of measured values requested (setting range: 1 to 65535) Transfer can be terminated prematurely using the command MEAS:STOP.
MEAS:START [CR]<LF>	Continuous transfer of measured values / statuses at regular intervals (measured value is refreshed 4 times per second). <ul style="list-style-type: none"> Synchronous query: Each measured value is transferred once only. The transfer of the first measured value may be delayed slightly. Transfer is stopped with the command MEAS:STOP.
MEAS:STOP [CR]<LF>	Stops continuous transfer

Response values:

<d.dddesdd><, unit> [, ovlid] [, bat] <CR><LF>

Example: 1.234e-07, T, N, O

Response	Explanation
unit	Units of measured value; depends on the operating mode selected by SET:MODE <ul style="list-style-type: none"> • T = Tesla (in "Field strength" mode only) • % = Percentage of limit value (in "Exposure STD" mode only)
ovlid	Overload indicator; for CALC:OVLD ON only <ul style="list-style-type: none"> • N = no overload, measured value valid • ! = overload state occurred during measurement, reject measured value
bat	Battery status; for CALC:BAT ON only <ul style="list-style-type: none"> • L = Battery is discharged • O = Battery is charged

↪ Remote control command **SET:LOW_CUT**, see page 7-10

↪ Remote control command **CALC:BAT**, see page 7-17

↪ Remote control command **CALC:OVLD**, see page 7-18

SYST:KLOC<SP><param>[CR]<LF>

SYST:KLOC?[CR]<LF>

Response:

<param><CR><LF>

Meaning:

Locks / unlocks the keypad of the basic instrument.

param	Explanation
ON	Locks the basic instrument keypad. The instrument does not respond if any of the operating keys are pressed in this status.
OFF	Unlocks the instrument keypad.

Table 7-11 Basic instrument keypad lock settings

Note: The basic instrument can still be switched off using the **ON/OFF** key when the keypad is locked. The keypad is unlocked when you switch the basic instrument on again.

Instrument status query

CALC:BAT<SP><param>[CR]<LF>

CALC:BAT?[CR]<LF>

Response:

<param><CR><LF>

Meaning:

Activates / deactivates battery status information.

param	Explanation
ON	Battery status response with every measured value transfer.
OFF	No battery status response.

Table 7-12 Battery status response settings

The battery status is appended to the response values for a field measurement.

↪ Remote control command **MEAS**, see page 7-14

CALC:OVLD<SP><param>[CR]<LF>

CALC:OVLD?[CR]<LF>

Response:

<param><CR><LF>

Meaning:

Sets whether or not overload status information is returned at the end of a result:

param	Explanation
ON	Overload status indicator response every time a measured value is transferred.
OFF	No overload status indicator response.

Table 7-13 Overload status indicator response settings

The overload status indication is appended to the response values for a field measurement.

↪ Remote control command **MEAS**, see page 7-14

MEAS:BAT?[CR]<LF>

Response:

<param><CR><LF>

Meaning:

Queries the current battery voltage (measured value, units) separated by a comma.

Example: 4987, mV

SYST:BAT?[CR]<LF>**Response:**

<param><CR><LF>

Meaning:

Queries the battery charge status.

param	Explanation
BAT_OK	Battery is charged
BAT_LOW	Battery is discharged

Note: If you regularly query the charge status, the instrument will continue to operate for about 15 minutes after the first appearance of the "BAT_LOW" message. The instrument will then switch off automatically.

IDN?[CR]<LF>*Response:**

Returns the following information, separated by commas:

- Manufacturer
- Instrument name
- Article number
- Serial number
- Version number

Example:

NARDA-STS,ELT-400,BN-2300/01,A-0001,V1.00

Note: The text length for each item of information is limited to 12 characters.

SYST:ERR?[CR]<LF>**Response:**

<param><CR><LF>

Meaning:

Queries the error status resulting from the last command used. The response value indicates the correct interpretation of the previously sent command or the instrument status.

param	Explanation
0	No error
-109	Incomplete parameter
-110	Unknown command
-224	Parameter value outside range limits
-290	Incorrect probe type connected
-300	Instrument is not (yet) in measurement phase
-310	No probe connected
-400	No data ready

Table 7-14 **SYST:ERR** command response values

Data transfer protocol

SYST:XONXOFF<SP><param>[CR]<LF>

SYST:XONXOFF?[CR]<LF>

Response:

<param><CR><LF>

Meaning:

Selects the software handshake

param	Explanation
ON	Activates XON/XOFF software handshake
OFF	Deactivates XON/XOFF software handshake

Setting the default values

SYST:DEFAULTS[CR]<LF>

Meaning:

Sets the instrument settings to their default (factory) values.

↳ Annex A: Default values

The instrument information and the current measurement units are also returned.

Example: NARDA-ST5, ELT-400, BN2300/01, A-0001, V1.00, %

8 Specifications

The specifications are valid for the following conditions and settings unless otherwise stated:

- Ambient temperature: 23 °C (± 3 °C)
- Relative humidity: 40% to 60%
- Sine wave signal (CW)
- Root mean square value (RMS)
- Operation from rechargeable or alkaline batteries

Note: The use of connecting cables for the external connectors (RS-232, Scope and Charge) can alter the specifications and the measured value that is displayed. If you notice any such changes, experiment by moving the position of the cable in the field until the coupling effects are minimized.

The technical specifications may change due to product developments. The latest technical specifications can be found in the datasheet of the product. The datasheet can be downloaded from the Narda website www.narda-sts.com under the corresponding product page.

8.1 Functional principle

The voltage induced in a measurement coil (probe) is evaluated in order to measure the magnetic flux density. The signal voltage is digitized and evaluated by a digital signal processor (DSP). The DSP simulates the selected filter characteristics and calculates the flux density resulting from the voltage.

The orthogonal configuration of the three measurement coils allows the field to be measured isotropically (i.e. independent of spatial direction). The three channels are output with their correct phases.

8.2 Specifications when using the 100 cm² probe

Frequency range (-3 dB), selectable		1 Hz to 400 kHz, 10 Hz to 400 kHz, 30 Hz to 400 kHz
Probe type		Magnetic (B) field
Sensor type		Isotropic coil 100 cm ²
Damage level ¹⁾	RMS	160 mT The damage level reduces linearly with increasing frequency above 77,5 Hz (1/f).
	Peak	226 mT The damage level reduces linearly with increasing frequency above 620 Hz (1/f). The damage level (peak) applies for pulse duration $\leq 15,6$ ms and duty cycle $\leq 1/64$
Measurement uncertainty ²⁾		$\pm 4\%$ (50 Hz to 120 kHz)
Mounting thread		1/4-20UNC-2B (standard thread)

1 Graphical representation of the damage level limit:

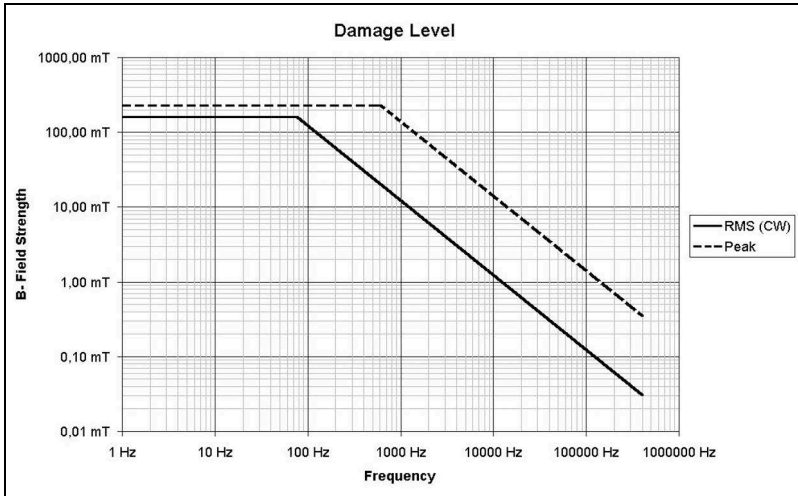

Fig. 8-1 Damage level

- 2 The measurement uncertainty includes flatness, isotropy, absolute and linearity variations (frequency range: 1 Hz to 400 kHz or 10 Hz to 400 kHz).
 The uncertainty increases at the frequency band limits (10 Hz, 30 Hz, 400 kHz) to ± 1 dB based on the nominal frequency response.

↪ Band limits: see page C-4

Exposure STD mode

Exposure evaluation	Comparison with standard (see Ordering information, page 8-11)			
MODE ³⁾	ICNIRP / IEC 62311 / 2013/35/EU		IEC/EN 62233	
RANGE	LOW	HIGH	LOW	HIGH
Overload limit	160%	1600%	160%	1600%
Noise level ⁴⁾ , typical	1%	5%	0.4%	2%
Resolution (RANGE: LOW)	0.001%			
Detection, selectable	Automatic according to selected standard, or RMS (averaging time 1 s), or Peak Value			
Display mode, selectable	Instantaneous or Max Hold			

³ Depends on type, see Ordering information, page 8-11

⁴ Detection: Automatic according to selected standard, IEC/EN 62233 based on ICNIRP reference values

Field strength mode

Frequency response ⁵⁾	Flat			
MODE ⁶⁾	320 μ T		80 mT	
RANGE	LOW	HIGH	LOW	HIGH
Overload limit	32 μ T	320 μ T	8 mT	80 mT
Noise level ⁷⁾ , typical	60 nT	320 nT	10 μ T	80 μ T
Resolution (RANGE: LOW)	1 nT			
Detection, selectable	RMS (averaging time 1 s) or Peak Value			
Display mode, selectable	Instantaneous or Max Hold			

5 Band limits: see page C-4

6 Depends on type, see Ordering information, page 8-11

7 For frequency range 10 Hz to 400 kHz and 30 Hz to 400 kHz only

Output

Analog scope output	Three channel (X-Y-Z)
Analog output level	The open-circuit analog output voltage is 800 mV when the field strength value corresponds to the overload limit (sensitivity = 800 mV / overload limit). Load impedance \geq 10 kOhm
Interface (remote control and readout)	RS-232 (19 200 baud, 8n1, XON/XOFF), 3-wire, 2.5 mm stereo jack

General specifications

Operating temperature range	-10 °C to +50 °C
Operating humidity range	<95% (30 °C) or <29 g/m ³ , non-condensing
Weight, typical	910 g (with probe)
Dimensions, typical	180 x 100 x 55 mm length x width x height (without probe), 290 mm length x 125 mm diameter (probe)
Display type	LCD with backlight; refresh rate 4 times per second
Battery	NiMH batteries (4 x Mignon, AA), exchangeable
Operating life, typical	12 h
Charger unit	100 to 240 V AC / 47 to 63 Hz, fits all AC line connectors
Charging time, typical	2 h
Calibration interval, recommended	24 months

8.3 Specifications when using the 3 cm² probe

Frequency range (-3 dB), selectable		1 Hz to 400 kHz, 10 Hz to 400 kHz, 30 Hz to 400 kHz
Probe type		Magnetic (B) field
Sensor type		Isotropic coil 3 cm ²
Damage level	RMS	1500 mT The damage level reduces linearly with increasing frequency above 30 Hz (1/f).
	Peak	2121 mT The damage level reduces linearly with increasing frequency above 240 Hz (1/f). The damage level (peak) applies for pulse duration ≤ 15,6 ms and duty cycle ≤ 1/64.
Measurement uncertainty ¹⁾		±6% (50 Hz to 120 kHz)
Mounting thread		1/4-20UNC-2B (standard thread)

- 1 The measurement uncertainty includes flatness, isotropy, absolute and linearity variations (frequency range: 1 Hz to 400 kHz or 10 Hz to 400 kHz).
The uncertainty increases at the frequency band limits (10 Hz, 30 Hz, 400 kHz) to ±1 dB based on the nominal frequency response.

↳ Band limits: see page C-4

Exposure STD mode

Exposure evaluation	Comparison with standard (see Ordering information, page 8-11)			
MODE ²⁾	ICNIRP / IEC 62311 / 2013/35/EU		IEC/EN 62233	
RANGE	LOW	HIGH	LOW	HIGH
Overload limit	1500%	15000%	1500%	15000%
Noise level ³⁾ , typical	10%	50%	4%	20%

Resolution (RANGE: LOW)	0.001 %
Detection, selectable	Automatic according to selected standard, or RMS (averaging time ¹ s), or Peak Value
Display mode, selectable	Instantaneous or Max Hold

² Depends on type, see Ordering information, page 8-11

³ Detection: Automatic according to selected standard, IEC/EN 62233 based on ICNIRP reference values

Field strength mode

Frequency response ⁴⁾	Flat			
MODE ⁵⁾	320 μ T		80 mT	
RANGE	LOW	HIGH	LOW	HIGH
Overload limit	300 μ T	3 mT	75 mT	750 mT
Noise level ⁶⁾ , typical	600 nT	3.2 μ T	100 μ T	800 μ T
Resolution (RANGE: LOW)	1 nT			
Detection, selectable	RMS (averaging time 1 s) or Peak Value			
Display mode, selectable	Instantaneous or Max Hold			

⁴ Band limits: see page C-4

⁵ Depends on type, see Ordering information, page 8-11

⁶ For frequency range 10 Hz to 400 kHz and 30 Hz to 400 kHz only

Output

Analog scope output	Three channel (X-Y-Z)
Analog output level	The open-circuit analog output voltage is 800 mV when the field strength value corresponds to the overload limit (sensitivity = 800 mV / overload limit). Load impedance ≥ 10 kOhm
Interface (remote control and readout)	RS-232 (19 200 baud, 8n1, XON/XOFF), 3-wire, 2.5 mm stereo jack

General specifications

Operating temperature range	-10 °C to +50 °C
Operating humidity range	<95% (30 °C) or <29 g/m ³ , non-condensing
Weight, typical	840 g (with probe)
Dimensions, typical	180 x 100 x 55 mm length x width x height (without probe), 250 mm length x 32 mm diameter (probe)
Display type	LCD with backlight; refresh rate 4 times per second
Battery	NiMH batteries (4 x Mignon, AA), exchangeable
Operating life, typical	12 h
Charger unit	100 to 240 V AC / 47 to 63 Hz, fits all AC line connectors
Charging time, typical	2 h
Calibration interval, recommended	24 months

8.4 Climatic environmental conditions

Environment classes

Environment class as per ...	Storage	Transport	Operation
IEC 60721-3	Class 1K3, 1M2	Class 2K4, 2M3	Class 7K2, 7M3
Temperature range	-5 °C to +45 °C	Low air temperature restricted -30 °C to +70 °C	Air temperature range extended (excluding AC adapter) -10 °C to +50 °C

8.5 Declaration of origin

Country of origin	Germany
-------------------	---------

8.6 Declaration of conformity

Hereby, Narda STS declares that this equipment is in compliance with the directives 2014/30/EU, EN 61326-1:2013, 2014/35/EU, EN 61010-1:2010, and 2011/65/EU.

The full text of the EU declaration of conformity is available at www.narda-sts.com.

8.7 Ordering information

ELT-400	Order number
Calibrated Basic Unit and B-field probe (100 cm ²), with calibration certificate, charger unit (fits all AC line connectors), operating / programming manual, and rechargeable batteries	
<ul style="list-style-type: none"> • EXPOSURE STD: ICNIRP 1998 gen. pub. • EXPOSURE STD: ICNIRP 1998 occ. • FIELD STRENGTH: 320 μT • FIELD STRENGTH: 80 mT 	2304/101
<ul style="list-style-type: none"> • EXPOSURE STD: IEC/EN 62233 • EXPOSURE STD: ICNIRP 1998 occ. • FIELD STRENGTH: 320 μT • FIELD STRENGTH: 80 mT 	2304/104
<ul style="list-style-type: none"> • EXPOSURE STD: IEC 62311 • EXPOSURE STD: ICNIRP 1998 occ. • FIELD STRENGTH: 320 μT • FIELD STRENGTH: 80 mT 	2304/105
<ul style="list-style-type: none"> • EXPOSURE STD: ICNIRP 2010 gen. pub. • EXPOSURE STD: ICNIRP 2010 occ. • FIELD STRENGTH: 320 μT • FIELD STRENGTH: 80 mT 	2304/106
<ul style="list-style-type: none"> • EXPOSURE STD: 2013/35/EU Low ALs • EXPOSURE STD: 2013/35/EU High ALs • EXPOSURE STD: 2013/35/EU Limbs ALs • FIELDSTRENGTH: 80 mT 	2304/107
<ul style="list-style-type: none"> • EXPOSURE STD: EMFV 2016 Low ALs • EXPOSURE STD: EMFV 2016 High ALs • EXPOSURE STD: EMFV 2016 Limbs ALs • FIELDSTRENGTH: 80 mT 	2304/108

8.8 Accessories (optional)

Probe extension cable (length 1 m)	2300/90.30
Serial interface cable (length 2 m) with Stereo jack / DB9	2260/90.51
Analog interface cable (length 3 m) with D Sub 15 / 3 x BNC	2260/90.80
Tripod, non-conductive (height 1.65 m)	2244/90.31
Tripod extension, non-conductive (height 0.5 m)	2244/90.45
Transport case	2245/90.07
B-field probe 3 cm ² <i>(Upgrade required for ELT-400 with Firmware Version below 2.1 or with serial number between A-0001 and H-9999)</i>	2300/90.20

Annex A: Default values

The table below lists the default values (ex-works settings) of the ELT-400:

- when the instrument is switched on,
- after the remote control command SYST:DEFAULTS has been executed.

Parameter	Default setting
RANGE	HIGH
MODE	Depends on the instrument version selected (built-in operating modes) <ul style="list-style-type: none"> • Default is the operating mode shown farthest to the left on the basic instrument.
DETECT (detection mode)	Depends on the mode selected <ul style="list-style-type: none"> • RMS if a field strength mode is preset • STND if an Exposure STD mode is preset
MAX HOLD (display function)	OFF (current measurement value is displayed)
LOW CUT (lower frequency range limit)	10 [Hz] (30 [Hz] in initial series)
Status display <ul style="list-style-type: none"> • MAX HOLD • OVLD 	Cleared Cleared
CALC:BAT	OFF (battery status not returned at the end of a result transfer)
CALC:OVLD	OFF (overload status not returned at the end of a result transfer)
SYST:KLOCK	OFF (no keypad lock)
SYST:XONXOFF	ON (data transfer protocol activated)

Table A-1 Default values

The following table shows the status of the major parameters after various actions.

Parameter	Status of parameter after action			
	Change of measuring range [RANGE]	Change of operating mode [MODE]	Change of lower frequency range limit [LOW CUT]	Change of probe
	Status of parameter after remote control command			
	SET: RANGE	SET: MODE	SET: LOW_CUT	
RANGE	As set	Unchanged	Unchanged	Unchanged
MODE	Unchanged	As set	Unchanged	Unchanged
DETECT (detection mode)	Unchanged	Variable ¹	Unchanged	Unchanged
MAX HOLD (display mode)	OFF	OFF	OFF	OFF
LOW CUT (lower frequency range limit)	Unchanged	Unchanged	As set	Unchanged
Measured values / display status of the following instrument functions:				
<ul style="list-style-type: none"> • RMS, PEAK, STND • MAX HOLD • OVLD 	Cleared Cleared Cleared	Cleared Cleared Cleared	Cleared Cleared Cleared	Cleared Cleared Cleared
CALC:BAT	Unchanged	Unchanged	Unchanged	Unchanged
CALC:OVL	Unchanged	Unchanged	Unchanged	Unchanged
SYST:XONXOFF	Unchanged	Unchanged	Unchanged	Unchanged
¹ Depends on the selected operating mode: - RMS in Field strength mode - STND in Exposure STD mode				

Table A-2 Status of major parameters after various actions

Annex B: Exposure STD mode

Technical background

Health and safety standards prescribe various methods for determining field exposure. The field strength is usually expressed in terms of magnetic induction or flux density and represented by the letter B. The reference values stated in the standard are compared with the measured values:

$$B_{\text{meas}} \leq B_{\text{ref}}$$

In calculating the exposure, this means:

$$\frac{B_{\text{meas}}}{B_{\text{ref}}} \leq 1 \text{ (100 \%)}$$

The result of the exposure calculation is always expressed as a percentage of the reference value. If the measured value is exactly the same as the reference value, the result is “100 %”. Smaller values directly indicate that the limit has not been exceeded. It is therefore not necessary to express the result in units of field strength (mT) to assess the exposure level.

For this reason, the result displayed in “Exposure STD” mode is not the measured field strength but rather the exposure level in percent as already calculated. There is no need to find out the reference value from the standard and calculate the exposure level.

Derivation of exposure calculation in Exposure STD mode

The reference values are specified in the form of tables or curves in the various standards. This information can be split into different components for the purposes of further discussion:

- Limit value curve frequency dependency
- Limit value curve field strength dependency (exposure range)

The function of “Exposure STD” mode is illustrated by taking these items separately.

Limit value curve frequency dependency

The frequency response describes the degree to which the field strength at a given frequency f_1 may differ from that at another given frequency f_2 for the limit value to be achieved in both cases. The limit value curve can thus also be interpreted as an attenuation curve.

This (attenuation) curve is simulated in “Exposure STD” mode by several first-order filters (Attenuation characteristics of filters used in ELT-400: see page B-5). The relevant corner frequency is taken from the standard. The abrupt transitions at the corner frequencies are smoothed by the filters, leading to discrepancies of up to 3 dB. These deviations are accepted by ICNIRP (“Guidance on Determining Compliance of Exposure to Pulsed and Complex Non-Sinusoidal Waveforms below 100kHz”, Health Physics Vol. 84 No. 3, 2003) since they correspond to the biological effect of the field on humans.

The filters in the ELT-400 are switched to correspond with the relevant standard as well as to the selected exposure range.

Example: Limit values for 50 Hz and 150 Hz are taken from ICNIRP 1998. The corresponding reference values are 100 μT and 33.3 μT , i.e. the permitted values differ by a factor of 3. If the field at 50 Hz is attenuated by the filter during the measurement by a factor of 3 compared to the field at 150 Hz, both displayed values will be the same when the field strength reference value is reached.

Frequency measurement is not required, since the filter converts the frequency information into the appropriate attenuation. This also avoids the uncertainty in measuring the frequency of a signal of unknown shape (e.g. harmonics, interference frequencies, etc.).

Note: This method has long been used with noise level meters.

Limit value curve field strength dependency

Since the frequency dependency of the reference values is fixed by the filters, only the level dependency for the selected exposure range needs to be scaled appropriately. The instrument must indicate the value 100 % when the limit value is reached.

This scaling is done during manufacture of the ELT-400. The display is adjusted accordingly at any given frequency. Switching the exposure level e.g. from “General Public” to “Occupational” takes place in the same way.

You therefore do not need to know the reference values at all.

Advantages of this method

This method is particularly useful when the signal shape is unknown, e.g. multiple-frequency fields or pulsed fields. The RMS and peak detectors ensure that such fields are evaluated properly. The ELT-400 continuously and automatically selects the detectors that are appropriate to the standard.

Measurements and calculations are made continuously and without interruption. This ensures that every pulse or change in the field is registered and measured correctly.

Please note

When you compare the results from the ELT-400 in “Exposure STD” mode with those from other field measuring instruments, some possible factors that need to be taken into account are:

- The comparison system must also measure isotropically and combine the results from the three channels correctly.
- The different bandwidths and the lower frequency limits of comparison instruments can affect the results considerably.
- The broadband measurement most often used can only be used for single-frequency fields. This method does not give a reliable result if the signal shape is unknown. Any frequency measurement that may be performed can be subject to extreme errors, so it is impossible to stipulate the correct reference values.
- The effective cross sectional area and the positioning of the measurement sensors (i.e. distance from the field source) significantly affect the results, particularly in the near field.
- FFT analyzers usually show the results as peak values. The corresponding reference values from the standard should be applied. Spectral components must not be ignored. The recording period of 1 second should also be taken into account.

If the results of isotropic (three channel) FFT analysis are combined, the phase information is lost. Linear summation of the individual results for each spectral line leads to a high measurement result that is usually much higher than the real value.

Attenuation characteristics of filters used in ELT-400

Note: Curves are for low-cut 1 Hz and 400 kHz band limiting filter.

ICNIRP 1998 weighting

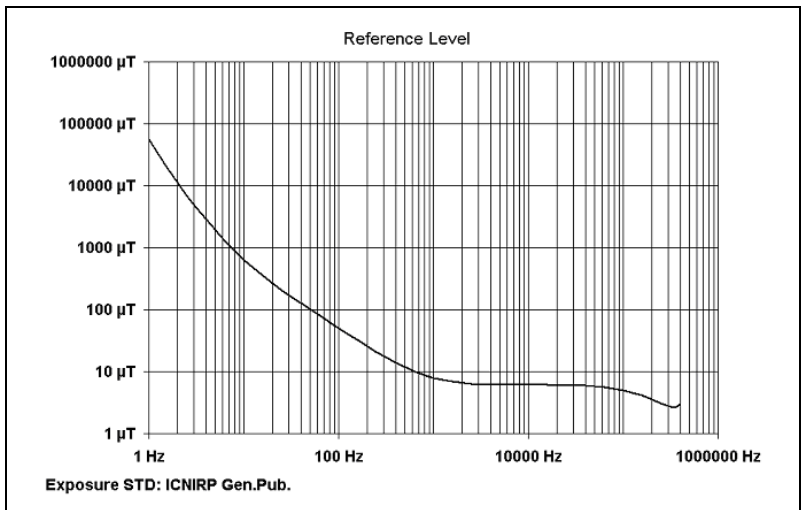
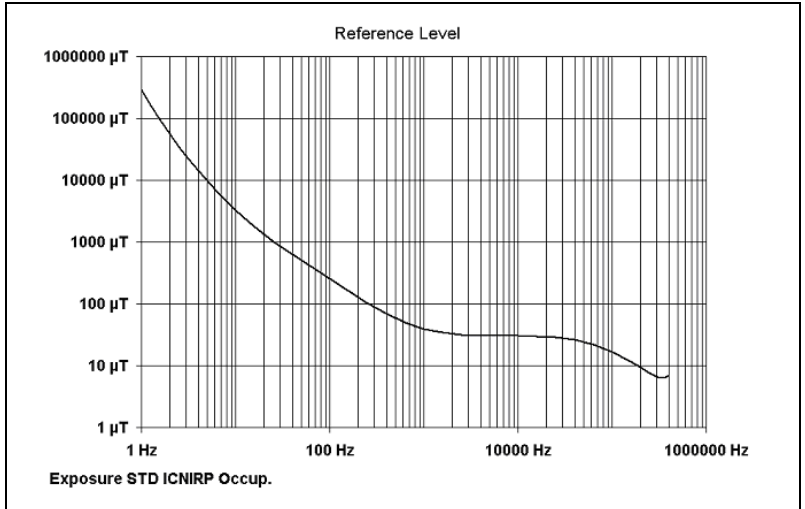

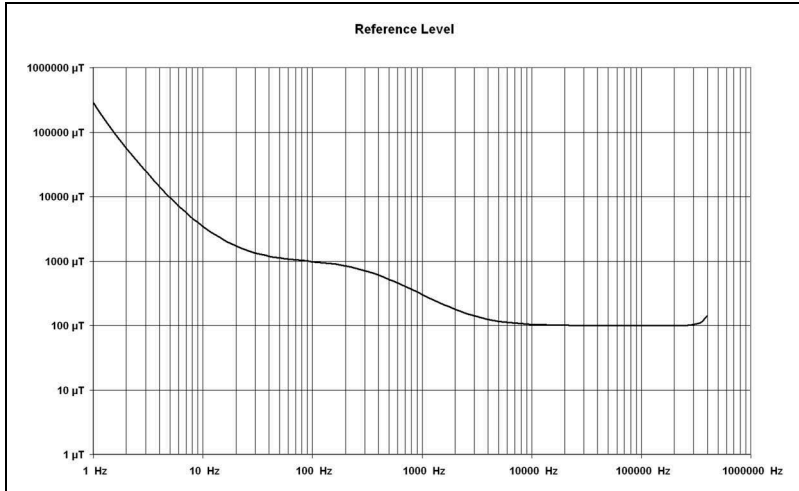
ICNIRP 2010 weighting

Exposure STD: ICNIRP 2010 Occup.
Exposure STD: 2013/35/EU Low Action Levels

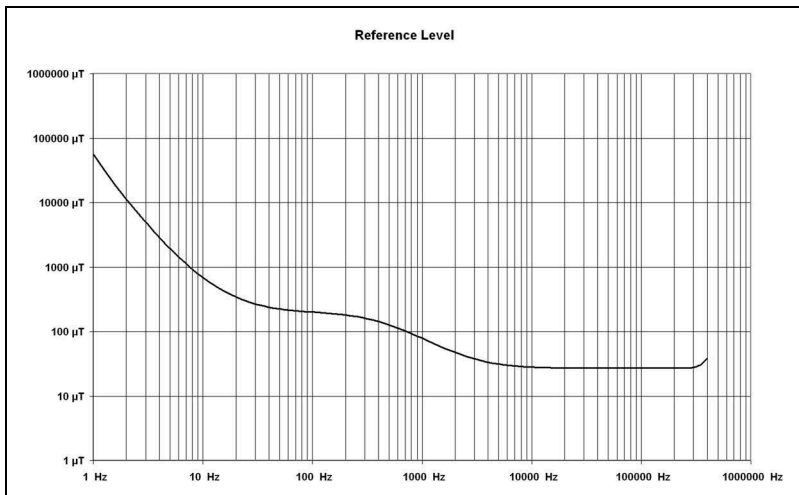

Exposure STD: ICNIRP 2010 Gen.Pub.

2013/35/EU and EMFV 2016 weighting

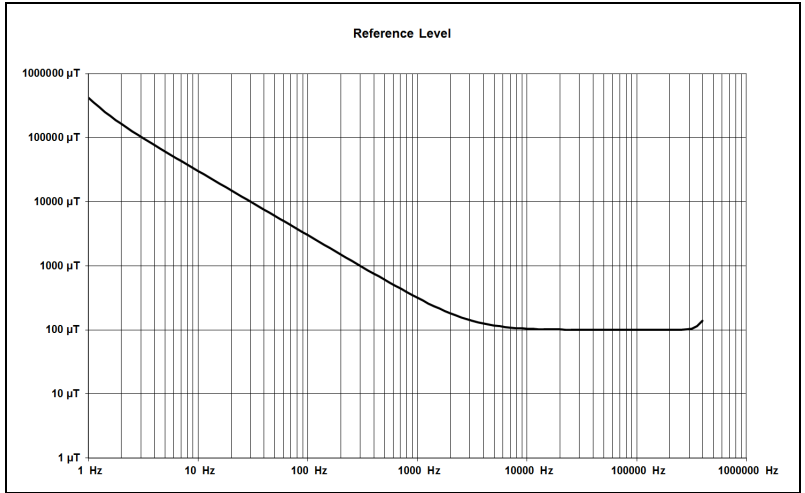

EXPOSURE STD: 2013/35/EU High Action Levels
EXPOSURE STD: EMFV 2016 High Action Levels

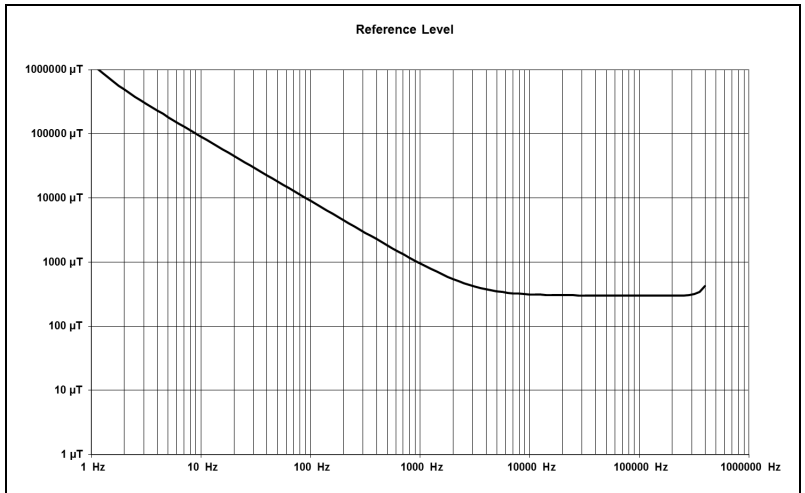

EXPOSURE STD: 2013/35/EU Limbs Action Levels
EXPOSURE STD: EMFV 2016 Limbs Action Levels

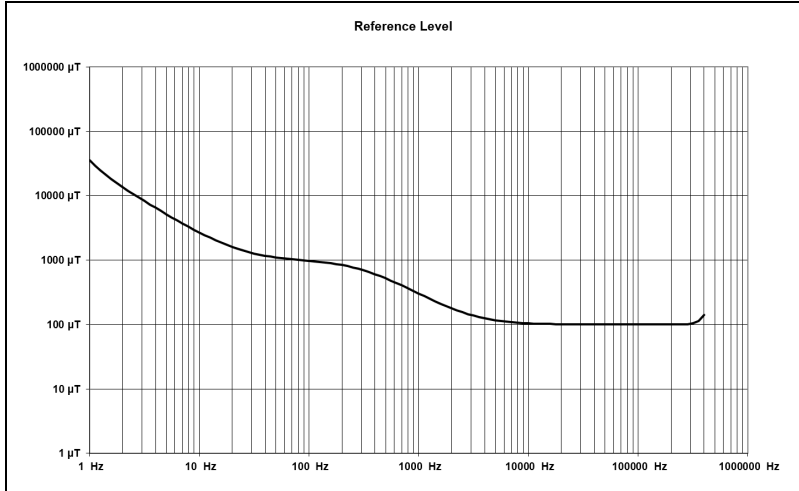

Exposure STD: EMFV 2016 Low ALs

BGV B11 weighting

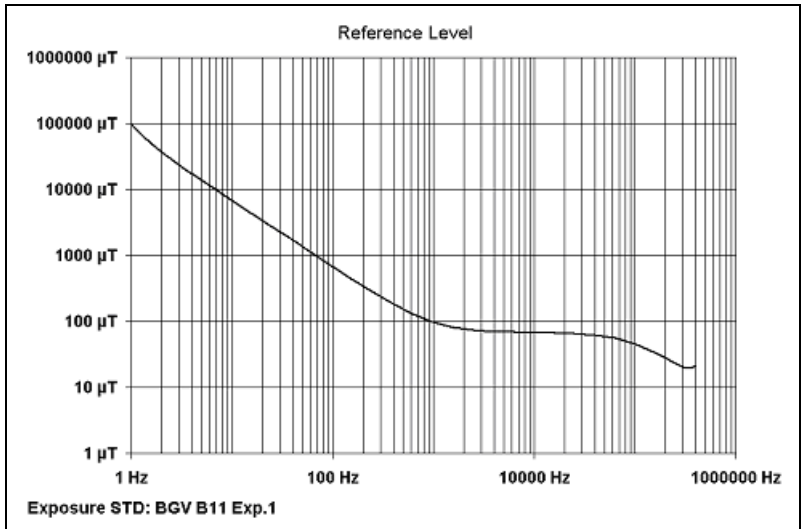
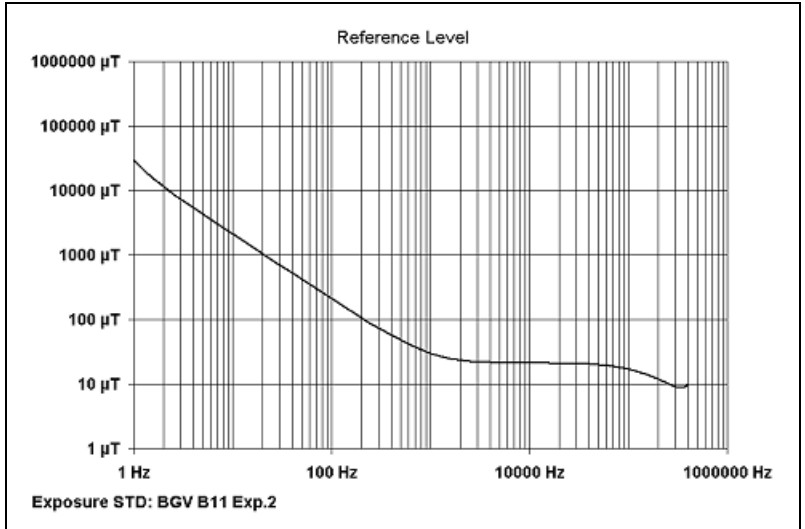

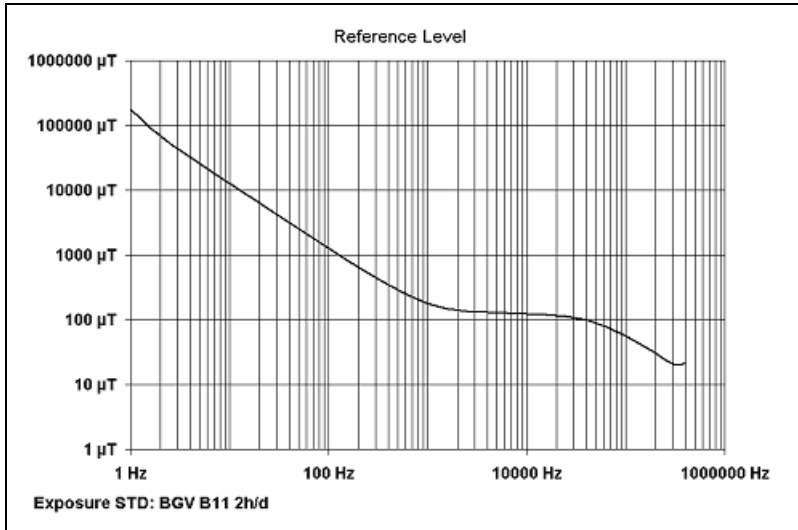

IEC/EN 62233 weighting

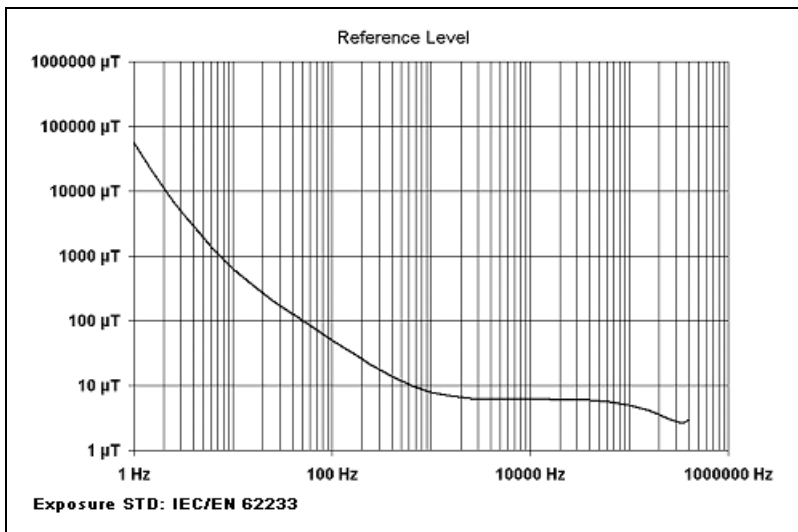

Annex C: Instrument function

Functional principle

The voltage induced in the measurement coils (field probe) is evaluated in order to measure the magnetic flux density. The signal voltages are digitized and evaluated by a digital signal processor (DSP). The DSP calculates the measurement result from the voltages. The orthogonal configuration of the three measurement coils allows the field to be measured isotropically (i.e. independent of spatial direction).

Block circuit diagram

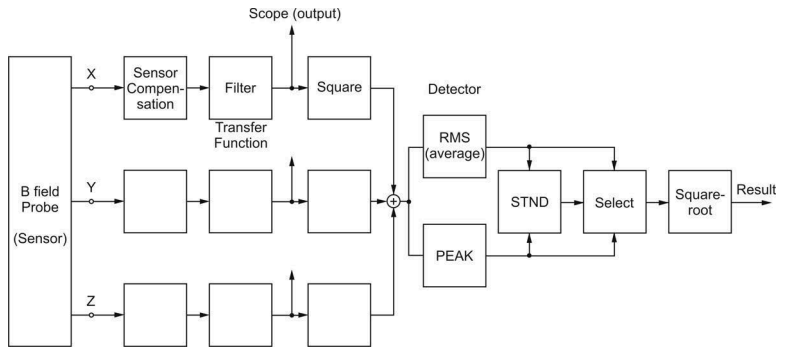

Fig. C-1 Block circuit diagram

Transfer function

The transfer function defines the intended frequency response of the measuring instrument and includes the field probe measuring coils.

The transfer functions for the various operating modes differ significantly from each other.

Operating mode	Transfer function
EXPOSURE STD	<ul style="list-style-type: none"> • Takes the frequency response of the limit value curve and the selected exposure range into account. • Attenuation occurs at the frequency range limits.
FIELD STRENGTH	<ul style="list-style-type: none"> ↳ Band limits: see page C-4 • Is independent of frequency (flat) over a wide range. • Attenuation occurs at the frequency range limits. ↳ Band limits: see page C-4

Detection mode / Detector

The ELT-400 simultaneously measures the RMS value and the peak value of the magnetic field. Both values are available immediately after the detection mode is switched. The measured values are continuously (every 250 ms) updated and displayed.

RMS value

The RMS value \hat{B} of the magnetic flux density is calculated from the RMS values for each of the three measurement axes, i.e. \hat{B}_x to \hat{B}_z .

$$\hat{B} = \sqrt{\hat{B}_x^2 + \hat{B}_y^2 + \hat{B}_z^2}$$

The RMS value is always independent of the time phases of the field components.

The averaging (integration) time for the RMS calculation is fixed at 1 second to conform with the relevant personal safety standards.

Peak value

The peak value \hat{B} of the magnetic flux density is calculated from the variation with time $B_x(t)$ through $B_z(t)$ of the magnetic flux density in each of the three measurement axes.

$$\hat{B} = \text{Max} \left\{ \sqrt{B_x^2(t) + B_y^2(t) + B_z^2(t)} \right\}$$

The peak value always depends on the phases of the measured field components. For this reason, vectorial addition is used.

Std (Standard)

The results in “Exposure STD” mode are expressed as a “percentage of the limit value”. The detection modes to be used for the measurement are specified – sometimes within separate clauses – by the relevant personal safety standards. They are of decisive importance in ensuring that the results are measured correctly, regardless of the signal shape (multiple or single frequency fields, pulsed fields).

There are some standards where both the RMS value and the peak value must be taken into account at the same time in order to determine exposure. The ELT-400 compares both measurement results continuously and displays the relevant measured value, applying the prescribed weighting factor where necessary.

Band limits

The signal is attenuated according to the following function at the upper and lower limits of the frequency range.

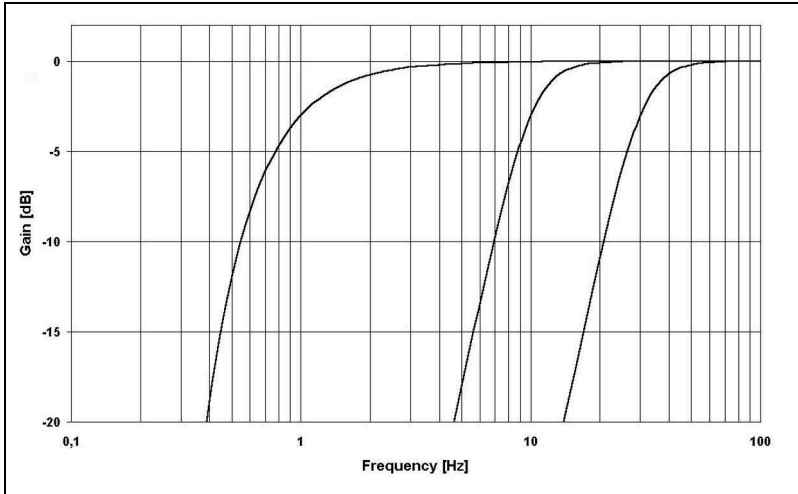

Fig. C-2 Lower band limits (LOW CUT = 1 Hz, 10 Hz and 30 Hz)

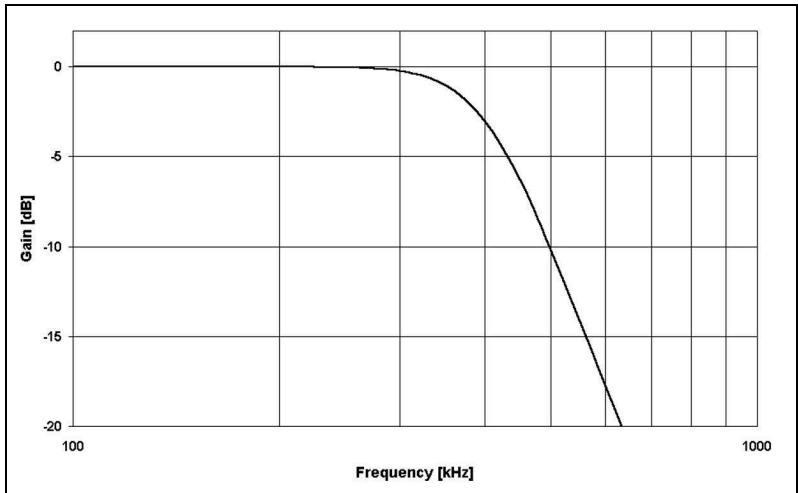

Fig. C-3 Upper band limit

Settling time

The variation with time of the field under investigation is sampled at intervals of about 1 μ s. This means that the internal signal voltages reflect any changes in the field immediately. The peak value is measured at the same, high sampling rate. The displayed measurement value is updated every 250 ms.

The RMS value is always determined by integrating (averaging) the variation in the field. Some personal safety standards specify an integration (averaging) time of 1 second for the frequency range in question. The ELT-400 takes this into account. The numerical result display will therefore require a settling time of 1 second if there is a sudden increase in field strength. Short-term changes in the field (e.g. pulses) lead, as intended, to a smaller RMS value depending on the pulse duration. The display is updated every 250 ms.

Overload monitoring

The measurement signals of all three measurement channels (X, Y, Z) are monitored separately. The overload indicator is displayed if an overload occurs in at least one of the channels.

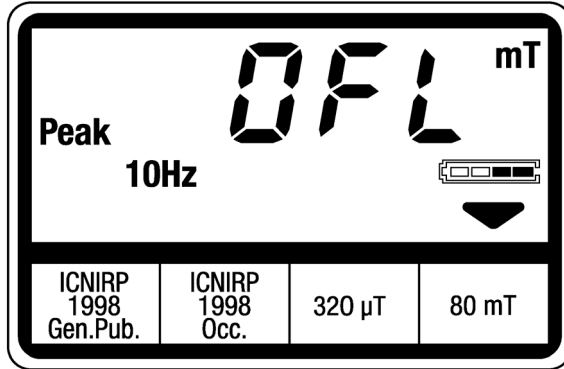

Fig. C-4 Overload indicator

The overload indicator is displayed as long as the result is not valid, i.e. normally for at least 1 second (standardized averaging time).

In MAX HOLD display mode, the overload indicator can only be cleared by switching off the MAX HOLD function.

↪ Selecting the display mode: see page 5-11

Annex D: Probe configuration / signal output

The internal sensor coils are arranged orthogonally. The configuration of the coils is not immediately visible externally.

If you require the result display to be referred to the spatial axes of the room in which the measurement is made, the probe coils must be configured so that they match the spatial axes of the room. This can be important when making EMC measurements, for example.

Use the diagram below to position the probe correctly.

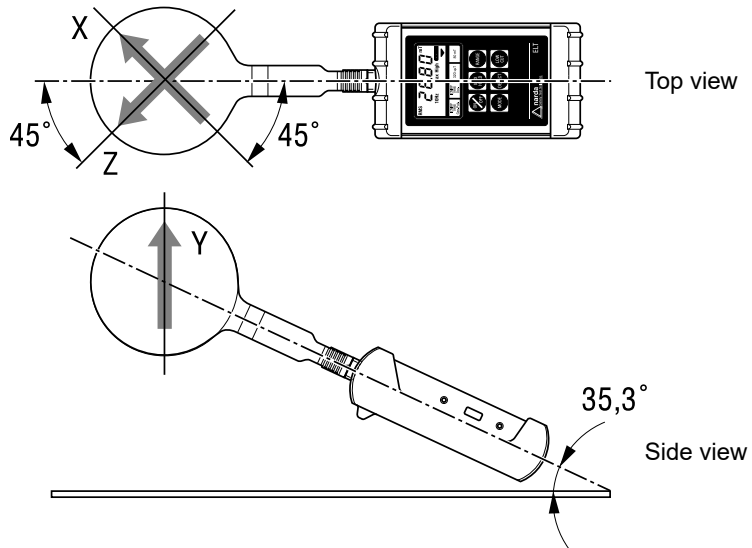

Fig. D-1 100 cm² cross-sectional area B-field probe layout.
The sensors in the 3 cm² B-field probe (optional) have the same layout but inverted polarity.

Positioning the probe

⇒ Tilt the ELT-400 up by exactly 35.3° from the horizontal and secure it in this position.

Top view: The effective coil cross sectional areas for the X and Z coils are perpendicular. They are each oriented at 45° to the center axis.

Side view: The Y axis is perpendicular with the coil cross sectional area horizontal.

Connecting cable

The following connections are provided if the analog interface cable (order number 2260/90.80) is used:

Coaxial plug:

- Red: X axis
- Green: Y axis
- Blue: Z axis

D-SUB15 plug:

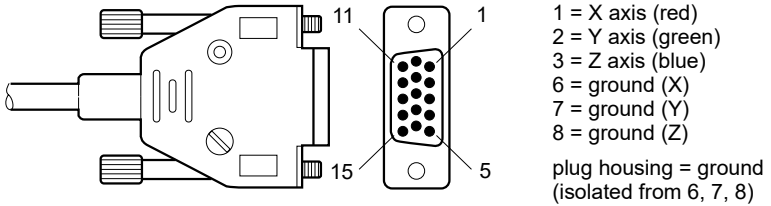

Fig. D-2 D-SUB15 plug connections (connecting cable)

Annex E: Overview of instrument connections

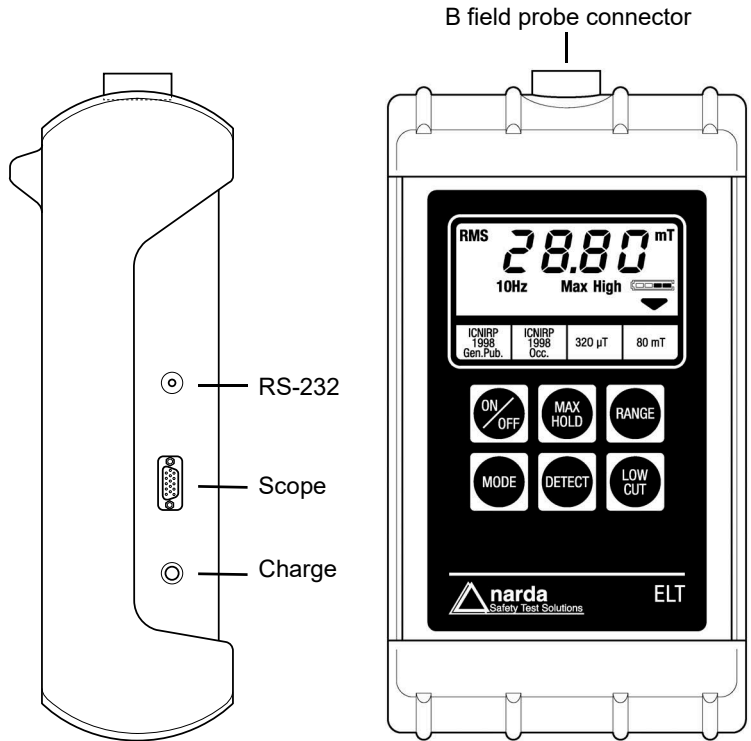

Fig. E-1 Instrument connections

Index of key words

A

- AC adapter / charger unit 2-6, 6-2
- Accessories 8-12
- Active probe 1-2, 5-14
- Alkaline batteries 6-1
- Application 1-1
 - EMC test laboratory 1-2
 - Everyday environment 1-1
 - Production areas 1-1

B

- B field probe 3-4
 - Connecting 3-4
 - Disconnecting 3-4
- Basic instrument keypad 4-1
- Batteries 4-4
 - Charging 3-3
- Block circuit diagram C-1
- Broadband measurements 1-2

C

- Charge 4-6
- Cleaning 6-2
- Conformity declaration 8-10
- Connecting up 2-2
- Connections, overview E-1

D

- Damage level 8-2, 8-6
- Default values A-1
- Detect 4-2, 5-9
- Detection mode 4-5, 5-9, C-2
- Detector C-2

- Direction of data flow 7-1
- Display backlight 4-5
- Display function 4-4
- Display mode 5-11
- Disposal 2-8

E

- EMC test laboratory 1-2
- Environment classes 8-9
- Evaluation schemes 1-2, 4-2, 5-2, 5-12
- Exposure 1-2
- Exposure STD 1-2, 5-1, 5-2, C-2

F

- FFT analyzer 1-2, 5-14
- Fiber optic cable 7-1
- Field strength 1-2, 5-1, 5-3, C-2
- Frequency range 8-2, 8-6
- Frequency response C-2
- Function test 5-6
- Functional principle 8-1, C-1

I

- Instrument
 - Connecting to the measurement computer (data cable) 7-2
- Instrument connections, overview E-1
- Instrument description 1-2
- Instrument function C-1

L

- Low Cut 4-2, 5-10

Lower frequency range limit 4-5
Lower measurement range limit 5-12

M

Max Hold 4-1, 5-11, C-6
Measured value 4-3
Measurement range 4-4, 5-10
Mode 1-2, 4-2

O

ON/OFF 4-1
Operating mode 4-5, 5-1, 5-8
Operating time 3-2
Origin, declaration of 8-9
Oscilloscope 1-2, 5-14
Overload display 5-13
Overload indicator C-6
Overload limit 8-3, 8-4, 8-6, 8-7
Overload monitoring C-2

P

Package contents 3-1
Packaging 3-1
Peak 5-9, C-2, C-3
Peak value C-3
Power supply 3-2
Probe configuration D-1
Proper use 2-2

R

Range 4-1, 5-10
Rechargeable batteries 2-7, 6-1
Remote control 7-1
 Cleaning up received data 7-6
 Querying instrument data 7-19
 Response data characteristics

7-6
Response string 7-6
Setting the parameters to their
default values 7-21
Use of remote control commands
7-3

Remote control commands
 Conventions 7-5
 In measurement mode
 (measuring) 7-4
 In ready mode (status query) 7-3

RMS 5-9, C-2

RS-232 4-6

S

Safety instructions 2-1
Scope 4-6
Settling time C-5
Specifications 8-1
Std (Standard) 5-9, C-3
Switching on 5-6

T

Test setup 3-4
Transfer function C-2
Transport damage 3-1

U

Unpacking 3-1

Narda Safety Test Solutions GmbH

Sandwiesenstrasse 7
72793 Pfullingen, Germany
Phone +49 7121 97 32 0
info@narda-sts.com

Narda Safety Test Solutions

North America Representative Office
435 Moreland Road
Hauppauge, NY11788, USA
Phone +1 631 231 1700
info@narda-sts.com

Narda Safety Test Solutions S.r.l.

Via Rimini, 22
20142 Milano, Italy
Phone +39 0258188
nardait.support@narda-sts.it

Narda Safety Test Solutions GmbH

Beijing Representative Office
Xiyuan Hotel, No. 1 Sanlihe Road, Haidian
100044 Beijing, China
Phone +86 10 6830 5870
support@narda-sts.cn

www.narda-sts.com