



Evaluation of exposure to pulsed magnetic fields by examining the variations in the spectrum and over time with ELT-400

Introduction

The ELT-400 is a device for measuring low frequency magnetic fields and for evaluating the field exposure that occurs in the workplace and in public areas. The ELT is typically used in areas such as industrial production plant that involves welding or induction heating equipment, and in the EMC test labs of equipment and automobile manufacturers. It is simple to operate, so it is easy to obtain precise measurement results and perform exposure assessments according to current standards such as ICNIRP 1998/2010, 2013/35/EU, IEC/EN 62233 or IEC 62311 in a short space of time. There are, however, a number of applications that require a deeper analysis of the magnetic fields by examining the variations in the spectrum and over time of pulsed fields, for example. The analog output of the ELT provides this facility when a digital oscilloscope is connected to it. The ELT is the only device on the market that can output the field strength signal as well as a signal that is weighted according to a particular standard from its analog output. This opens up some interesting possibilities for analysis, which are discussed in this Application Note. The methods described here can be applied to the evaluation of operating production line welding equipment and for optimizing magnetic field exposure levels during the development of electric vehicles.

The analog signal output of the ELT-400

The ELT-400 is equipped with a three channel analog output for the X, Y, and Z spatial axes. In **Field Strength mode**, the analog output voltages are proportional to the magnetic field strength (or magnetic flux density) incident on the probe, so they can be used to measure the field components in the X, Y, and Z directions.

In **Exposure STD (Weighted Peak) mode** the measured magnetic field is weighted according to a selected standard and the result is displayed as percentage exposure index, corresponding to the degree to which the limit value has been reached. The analog output is also weighted according to the transfer function of the selected standard. The signal outputs are switched to the outputs of the weighting filter for this purpose (Scope X, Y, Z; Figure 1). In weighted mode, the output voltage is proportional to the exposure index (EI), separately for each axis.

The peak detector is used for most standards (Weighted Peak method). This peak value is then displayed. Analysis of the weighted signal shows the signal components that are really critical and that have a decisive influence on the exposure index. The block circuit diagram of the ELT-400 is shown in Figure 1. The specifications for the output voltages and the axis assignments are given in the operating manual. The lower frequency limit of the measurement can be selected by the Low Cut Filter 1/10/30 Hz. For magnetic fields that include a DC component, the 1 Hz setting should be used to avoid signal distortion.

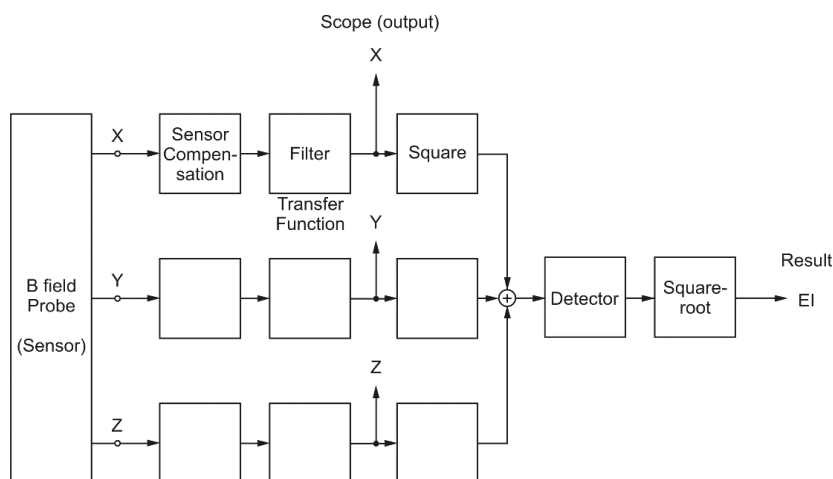

Figure 1: In weighted mode, the signal outputs are taken after the weighting filter

Signal recording

A standard oscilloscope can be used to record the signal. It is a good idea to use an instrument with built in FFT for more in-depth analysis, so that the signals can also be displayed in the frequency domain. A 4-channel device (e.g. PicoScope 4424) is needed in order to record the 3 axes and an additional trigger signal (e.g. the welding current through a Rogowski coil) if required. This simplifies the procedure, but it is not absolutely necessary for signal analysis. In principle, recording just one channel is enough, as long as it is not rotated outside the field.

A suitable connecting cable (article number 2260/90.80 D-SUB 15 to 3 x BNC) is available as an accessory. Figure 2 shows the equipment that is required for recording and analyzing the signal.



Figure 2: The ELT-400 measuring device with PicoScope 4424 USB data logger and laptop connected

Analysis of the weighted signal

Because the weighted output signal from the ELT-400 already includes the limit value trace from the standard, it is possible to draw conclusions about the exposure level from the waveforms that would be impossible or very difficult to obtain from an unweighted signal as might be recorded using a field meter.

Time domain analysis

Particularly for pulsed fields, it is possible that the exposure index is determined by even brief time periods in the field waveform, which can result in the permitted limit values being exceeded. Analysis of the weighted signal in the time domain is aimed at identifying these signal components (edges, spikes, etc.).

Time domain analysis is performed as follows:

1. Record the field or the current producing the field so that the waveform of the field is known. It is not necessary to record the entire field, just one component (X, Y, or Z) is sufficient. Further information about adding the field components together is found in [1].
2. Record the weighted output of the ELT-400; one component is enough here, too.
3. Optional: Scale the weighted output match the value of the displayed exposure index.
4. Optional: Place the weighted and unweighted field waveforms one above the other with their time axes corresponding.
5. Identify the field components that lead to a high exposure index.

Analysis in the time domain can be applied to both periodic and non-periodic field waveforms.

Frequency domain analysis

To analyze a field waveform in the frequency domain, the FFT of the signal is compared with the limit value curve of the standard, as shown in Figure 3. The limit curve is entered as a tolerance mask or included graphically in the printout of the measurement results.

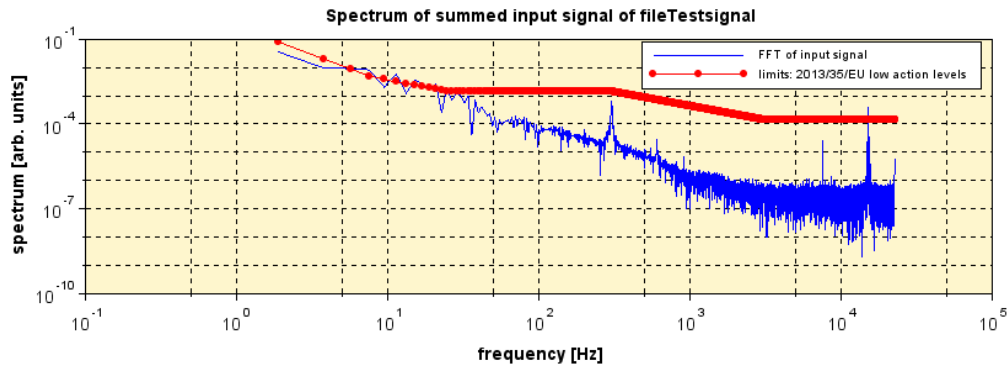

Figure 3: FFT of a signal with the limit value curve

Analysis using the ELT-400 is simpler, because the spectrum of the weighted signal can be viewed directly. The axis is scaled as the exposure index, where the value 1 (100 %) represents the limit value. Comparison with the standard is no longer necessary. By switching the oscilloscope to FFT mode, it is then possible to analyze the problematic signal components according to their magnitudes, as shown in Figure 4. The highest spectral component will then also indicate the highest contribution to the exposure index.

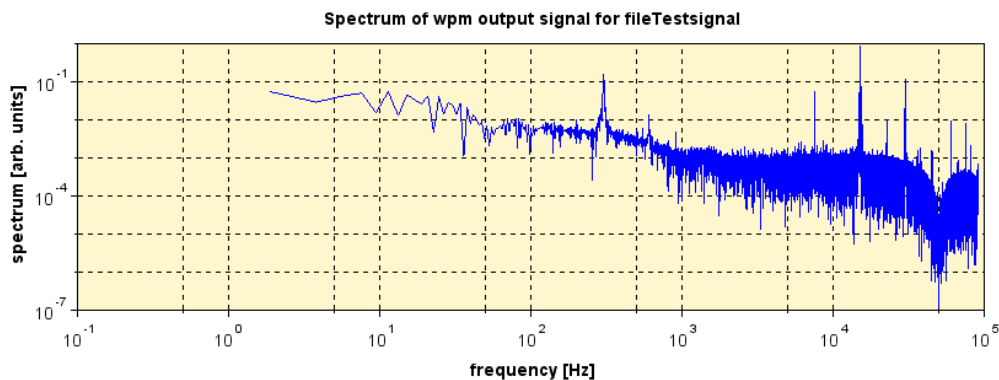

Figure 4: Spectrum of the weighted signal shown in Figure 3

Frequency domain analysis is performed as follows:

1. Record the weighted output from the ELT-400
2. Either calculate a FFT or use the FFT function of the oscilloscope
3. Identify the field frequencies that are relevant for the exposure index (highest spectral components)

Frequency domain analysis is suitable primarily for analyzing field waveforms with periodic components.

Example 1: Metal detector

Close to the coil of a metal detector, the ELT-400 indicates an exposure index of 188.9 % (weighted according to 2013/35/EU Low ALs). The unweighted field waveform of the signal is shown in Figure 5.

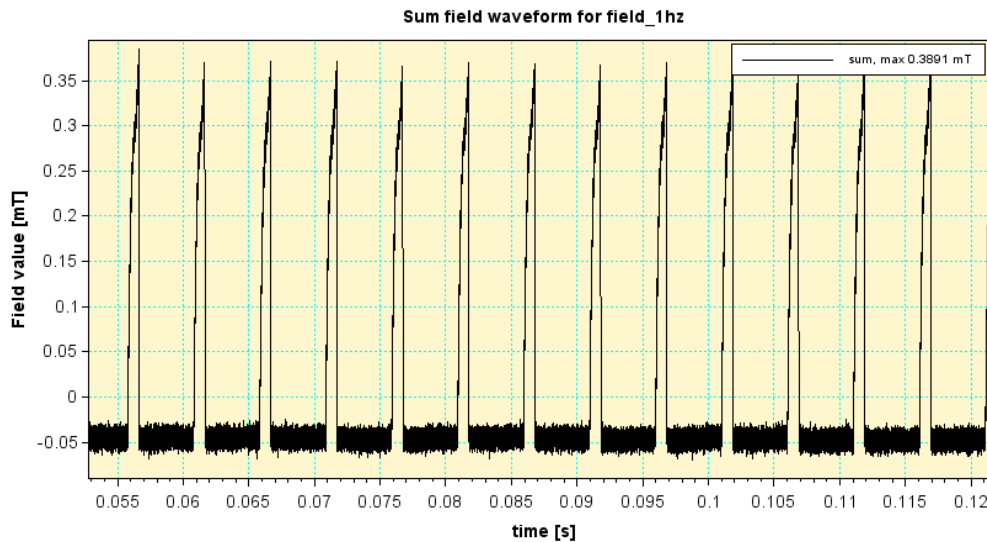

Figure 5: Field waveform close to the metal detector coil

To improve visibility, the oscilloscope time resolution is first set so that exactly one period of the signal is displayed. The weighted output is then recorded, and the time segment within the recorded period that is responsible for the exposure limit violation can be seen immediately. For more accuracy, the trace is scaled so that the peak value corresponds to 188.9 % and the two curves are placed one above the other.

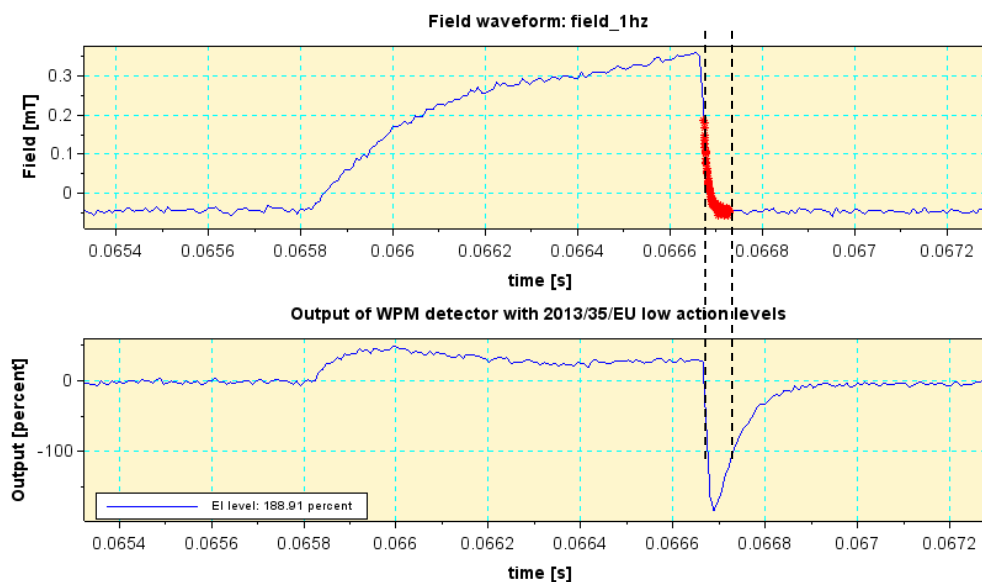

Figure 6: Time comparison of field waveform and weighted output for one pulse

The weighted output signal only exceeds 100% (or -100% in this case, as the output signal is negative in this example) within a short time period. The high exposure index is determined by this time period alone. If the section of the field waveform where the weighted output exceeds 100% is marked (shown bold red in the figure),

the falling edge of the signal can be identified as the culprit. There is no need to examine the rest of the pulse in order to reduce the exposure index.

Example 2: Welding impulse

The welding impulse from an inverter power source was measured in the immediate vicinity using the ELT-400, which determined an exposure index of 318.5 % (weighted according to 2013/35/EU Limbs). The impulse is made up from three signal components, as seen in Figure 7:

1. The low frequency basic welding impulse form with an amplitude of 55 mT. The 10 Hz high pass filter used for the measurement distorts the shape of the curve, but this is irrelevant to the analysis.
2. A superimposed sinusoidal oscillation with a frequency of 300 Hz and an amplitude of 2 mT.
3. A triangular oscillation with a frequency of 15 kHz and an amplitude of 0.7 mT superimposed on the sinusoidal oscillation.

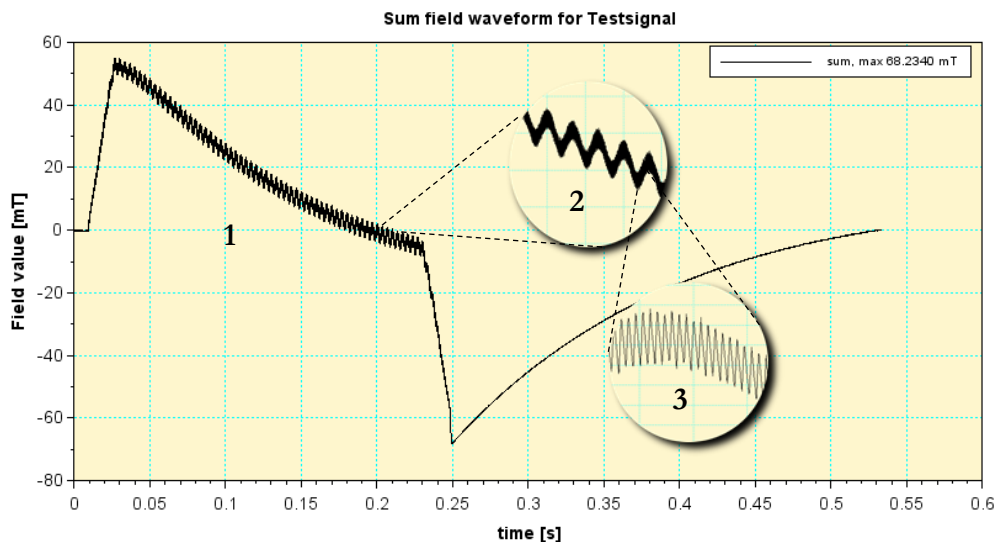

Figure 7: Welding impulse from an inverter power source, overview and zoom views

Firstly, the weighted signal in the time domain is used for analysis. The weighted signal is scaled up to 318.5 % and synchronized with the field waveform.

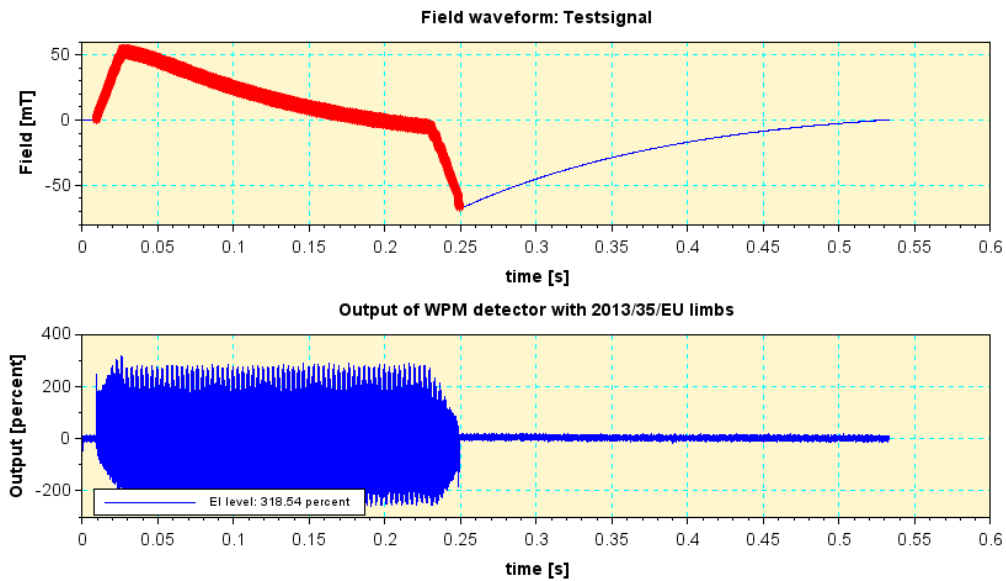

Figure 8: Field waveform and weighted output

Figure 8 shows that the weighted output exceeds 100% over a large segment. By zooming in on the signal (see Figure 9), it becomes clear that the weighted output follows the 15 kHz triangular oscillation with an amplitude of around 250%. Thus, this oscillation accounts for the major part of the exposure. Remarkably, it is the smallest signal component that determines the exposure index.

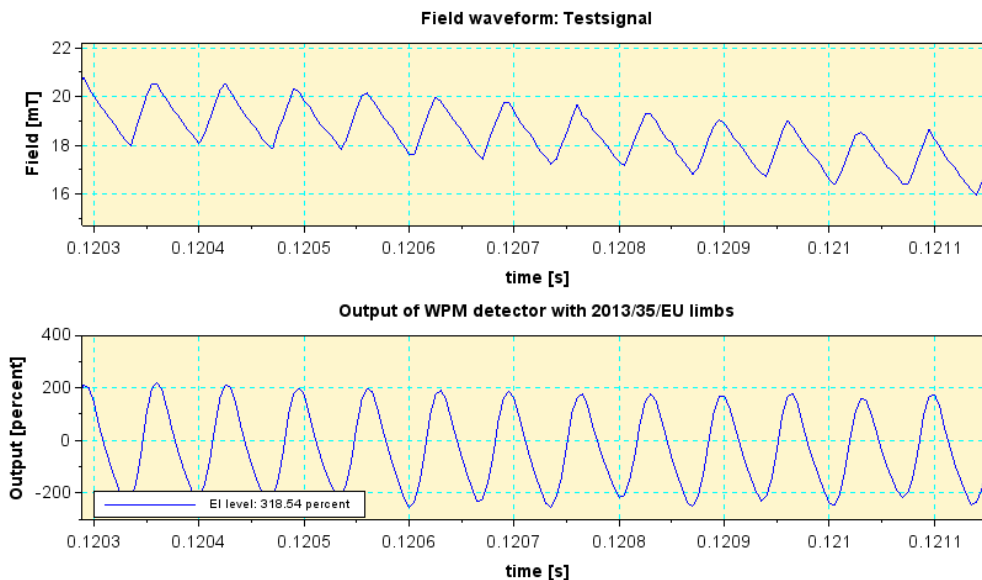

Figure 9: Highly magnified time segment from the signal waveforms shown in Figure 8

Since the signal has periodic components, analysis of the weighted signal in the frequency domain can also be useful. Figure 10 shows the FFT of the weighted welding signal. It is easy to see that the highest proportion of the signal occurs at 15 kHz, the same frequency as the triangular oscillation, which was also shown by the time domain analysis.

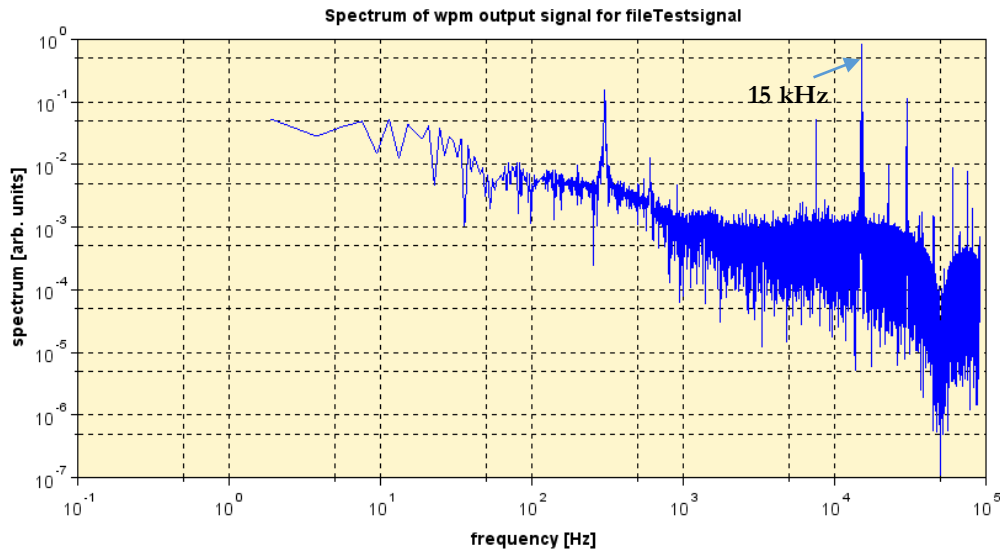

Figure 10: Spectrum of weighted welding signal

Summary

The evaluation methods described here first of all make it possible to easily determine and analyze the signal components that cause magnetic fields having complex waveforms. These methods are particularly suitable for setting up targeted protective measures for installed machinery and plant in the production industries as well as for the optimization during the development phase of motors, generators and cabling for electric vehicles, for example.

Bibliography

- [1] Keller H., The Weighted Peak Method in the Time Domain Compared With Alternative Methods for Assessing LF Electric and Magnetic Fields. Health Physics, 113(1):54-65, July 2017.
- [2] Directive 2013/35/EU of the European Parliament and of the Council of 26 June 2013 on the minimum health and safety requirements regarding the exposure of workers to the risks arising from physical agents (electromagnetic fields) (20th individual Directive within the meaning of Article 16(1) of Directive 89/391/EEC) and repealing Directive 2004/40/EC
- [3] ELT-400 data sheet, Narda NSTS 0517-E0205P, May 2017
- [4] ELT-400 operating manual, Narda 2300/98.11 Edition 10, June 2017

Narda Safety Test Solutions GmbH
Sandwiesenstrasse 7
72793 Pfullingen, Germany
Phone +49 7121 97 32 0
info@narda-sts.com

Narda Safety Test Solutions
North America Representative Office
435 Moreland Road
Hauppauge, NY11788, USA
Phone +1 631 231 1700
info@narda-sts.com

Narda Safety Test Solutions S.r.l.
Via Rimini, 22
20142 Milano, Italy
Phone +39 0258188 1
nardait.support@narda-sts.it

Narda Safety Test Solutions GmbH
Beijing Representative Office
Xiyuan Hotel, No. 1 Sanlihe Road, Haidian
100044 Beijing, China
Phone +86 10 6830 5870
support@narda-sts.cn