



NEED HELP?

SCAN OR CLICK HERE
TO CONTACT US



Air-Met Scientific
www.airmet.com.au

LASER ONE



OPERATING MANUAL



TABLE OF CONTENTS

1	DECLARATION OF CONFORMITY	3
2	WARNINGS ATEX	4
3	GENERAL DESCRIPTION	6
4	USER INTERFACE	7
4.1	OVERVIEW OF THE INSTRUMENT	7
4.2	CONNECTIONS	7
4.3	DISPLAY	7
4.4	NAVIGATION SYSTEM (MENU)	9
5	INSTRUMENT'S FUNCTION	10
5.1	SWITCHING THE INSTRUMENT ON AND OFF	10
5.1.1	Switch ON	10
5.1.2	Switch OFF	10
6	START SURVEY	11
6.1	USE OF GPS (OPTIONAL)	11
6.1.1	GPS Activation	11
6.2	SAVING LEAKS	12
6.3	DELETE DATA	12
6.4	DESCRIPTION OF THE PNEUMATIC CIRCUITS	12
6.4.1	Malfunction of the pneumatic circuit / Pump OFF	12
6.4.2	Restarting the pump operation	13
6.5	SAVING LEAKS	13
7	SETTINGS	14
7.1	MEASUREMENT RANGE	14
7.1.1	Methane measurement	14
7.1.2	Measure in absolute mode (ABS) and relative mode (REL)	14
7.2	SETTING THE ALARM THRESHOLD	15
7.3	ACOUSTIC AND VISUAL ALARM	15
7.4	BACKLIGHT - DISPLAY ILLUMINATION	15
7.5	BLUETOOTH DESCRIPTION (OPTIONAL)	15
7.6	RECHARGING THE BATTERY PACK	16
8	MAINTENANCE	17
8.1	REPLACING THE BATTERY PACK	17
8.2	REPLACING THE HYDROPHOBIC FILTER	18
9	CH₄ ACCURACY TEST	18
9.1	SERVICE AND CALIBRATION	18
9.2	ALARMS AND ERROR INFORMATION	19
10	WARRANTY	20
11	ACCESSORIES	23
12	APPENDIX A – SAFE USE OF THE INSTRUMENT	24
12.1	LASER RADIATION	24
12.2	OTHER PRECAUTIONS FOR THE USAGE	24
12.3	TESTING AND MAINTENANCE	24
12.4	REPAIR	24
13	APPENDIX B – TECHNICAL SPECIFICATION	25
14	APPENDIX C - INFORMATION ON DISPOSAL FOR USERS OF WASTE ELECTRICAL & ELECTRONIC EQUIPMENT	26
15	APPENDIX D – BLUETOOTH MODULE COMPLIANCE	27
15.1	UNITED STATES	27
15.2	CANADA	27
15.3	EUROPE	28

1 DECLARATION OF CONFORMITY

EU Declaration of Conformity

This Declaration of Conformity is issued under the sole responsibility of the manufacturer:

QED Environmental Systems

Cyan Park – Unit 3

Jimmy Hill Way

Coventry

CV2 4QP

UNITED KINGDOM

Product: Laser One and SEM 5000

Type of equipment:

Laser One – Mains Gas and Water Leak Detection

SEM 5000 – Landfill Gas Surface Emissions Monitor



The Laser One and SEM 5000 described above is in conformity with the relevant Union harmonisation legislation:

2014/34/EU: Equipment and protective systems intended for use in potentially explosive atmospheres (ATEX)

Ineris (0080) performed assessment against:

EN 60079-0:2012/A11:2013

EN 60079-11:2012

EN 60079-28:2015

Issuing certificate number INERIS 19ATEX0017X.

2014/53/EU: Radio equipment (RED)

EMC (Article 3.2):

EN 301 489-1

EN 301 489-17

EN 301 489-19

EN 61326-1:2012

FCC 15.107/109 + ICES 003

Signed for and on behalf of:

Name: Mr. Craig Millar

Position: Engineering Manager

Done at: QED Environmental Systems

2 WARNINGS ATEX

The operating manual must be read and fully understood before using the equipment.

This warning is in place so that the operator fully understands the product and its use within the application.

Battery must be replaced in a non-hazardous, safe area

Use only with battery pack QED PBLO

Battery pack QED PBLO must only be used with QED LASER ONE or SEM5000

Do not charge the device in a hazardous area OR only charge in a non-hazardous, safe area

Battery charging and communication (USB) must only be done in a non-hazardous, safe area with adapter QED CCLO 100189

Use only this device to charge QED LASER ONE and SEM5000

Maximum voltage $U_m \leq 15V$

The maximum voltage that can be applied to the external adapter **QED CCLO 100189** to charge QED LASER ONE and SEM5000 without invalidating the type of protection is 15 volts.

Do not connect the LASER ONE/SEM5000, the battery pack PBLO and adapter CCLO to other equipment.

These three devices are only designed to be used together to ensure the correct functionality of the device and guarantee the safety of the operator.

Do not open the device

Only the manufacturer or its authorised representatives can open the device for maintenance and repair.

Unauthorised opening of the device invalidates the integrity, certification and guarantee of the product.

ATEX accessories

Use only the following accessories with the instrument LASER ONE:

- Rechargeable battery pack lithium ion (PBLO.NNNN.YY 3,7V 4000mAh) Code: 205014
- External adapter (CCLO.NNNNN.YY) Code: 100189
- Power supply ($U_m < 15$ volts) Code: 423007
- Car cable power supply Code: 102010

Except in a situation of damage or repairs being required, it is recommended that the device is sent to QED annually for inspection, maintenance, and calibration.

	Non-USA	USA
Tel:	+44(0)333 800 0088	(800) 624-2026
Address:	Unit 3 – Cyan Park, Coventry, UK, CV2 4QP	2355 Bishop Circle West, Dexter, MI. 48130, USA

The apparatus type “LASER ONE” “SEM5000”, is usable in gas explosive atmosphere of group IIB and temperature class T3 for an ambient temperature from -25°C to +50°C.

The apparatus is category 2 and may be used in areas 1 and 2.

The respect of essential safety requirements, defined in annex II of the 2014/34/ UE directive from 26th February 2014, is obtain by the apparatus conformity to the standards:

EN 60079-0 : 2012 + A11 :2013	Explosive atmospheres – Part 0: Equipment – General requirements
EN 60079-11:2012	Explosive atmospheres – Part 11. Equipment protection by intrinsic safety « i »
EN 60079-28:2015	Explosive atmospheres – Part 28. Protection of equipment and transmission systems using optical radiation.

The following are applied to the apparatus:

Certificate number: INERIS 19 ATEX0017X.



Marking: II 2 G Ex ib op is IIB T3 Gb -25°C≤Ta≤+50°C

Operating Temperature: -25°C to +50°C

Note: The reduction of the range of temperature (-25°C to +50°C) results from functional conditions only.

3 GENERAL DESCRIPTION

The LASER ONE is a digital gas detection instrument manufactured by QED Environmental Systems Ltd. The intended use of the LASER ONE is to measure low concentrations of Methane in various applications (leakage survey of natural gas networks, control pinpointing outside buildings, quantifying Methane levels and laboratory applications for gas analysis).

The LASER ONE instrument has selective measurement of Methane due to the Laser technology used. The LASER ONE delivers reliable and accurate measurements of Methane concentrations, irrespective of whether the sample contains other gases or hydrocarbons. Due to its lightweight design and modest size, LASER ONE can be easily transported and is ideal for measuring Methane concentrations in the field (landfills, site investigations or gas networks). Its capability to measure from lower concentrations to higher concentrations changing between ranges rapidly, makes LASER ONE the appropriate instrument for the detection of leaks from gas meters and the gas distribution network and also as an analyser for the quantification of gas emissions. Thanks to its metrological sensitivity, accuracy, stability and response, LASER ONE is particularly suited to any application requiring the measurement of Methane concentrations in sampling mode or in line (option).

The single-dial function selector makes the LASER ONE easy to use and the large, back-lit LCD display provides easy to read menus and results. The LASER ONE has a measuring range covering 0 to 1,000,000 PPM (part per million) or 100% Methane concentration.

The LASER ONE also offers a rapid response time, improving the efficiency and saving time. The exceptional reactivity of the LASER ONE laser technology provides excellent results during field scans for traces of methane. The noteworthy combination of high sensitivity and rapid response deliver outstanding measurement quality.

The LASER ONE has the user definable option to switch between 'Absolute' and 'Relative' measurements, the 'Absolute' setting will include the background Methane level or the 'Relative' setting will remove this background level from the subsequent reading (see section 7.1.2).

LASER ONE is equipped with an integral GPS device and the capability to record locational data to compliment measured gas analysis results. This makes LASER ONE an accomplished instrument to work conveniently in the field with efficient results.

LASER ONE exists in an ATEX version and has been certified with the intrinsic safety protection mode and has obtained the following marking:

 II 2 G Ex ib op is IIB T3 Gb -25°C ≤ T_A ≤ +50°C

In hazardous environments, the user must adhere to the EN 1127-1:2019 (Explosive atmospheres. Explosion prevention and protection - Basic concepts and methodology) and the CLC/TR 50404:2003 "Electrostatics Code of practice for the avoidance of hazards due to static electricity".

Note: The images shown in this user manual are for illustrative purposes only.

4 USER INTERFACE

4.1 Overview of the instrument

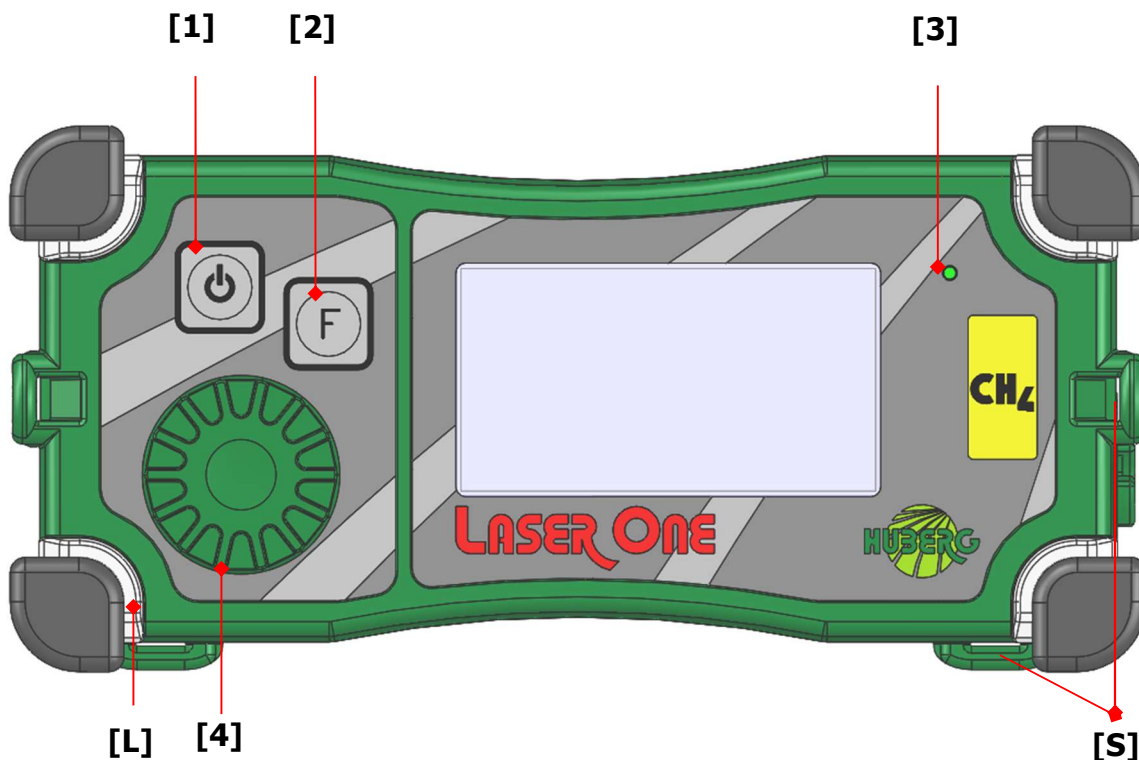

	Description
[1]	ON/OFF button + Backlight
[2]	Function button
[3]	Buzzer
[4]	Jogdial
[L]	LED Alarm Lights and Impact Bumpers
[S]	Carry strap Connectors

4.2 Connections

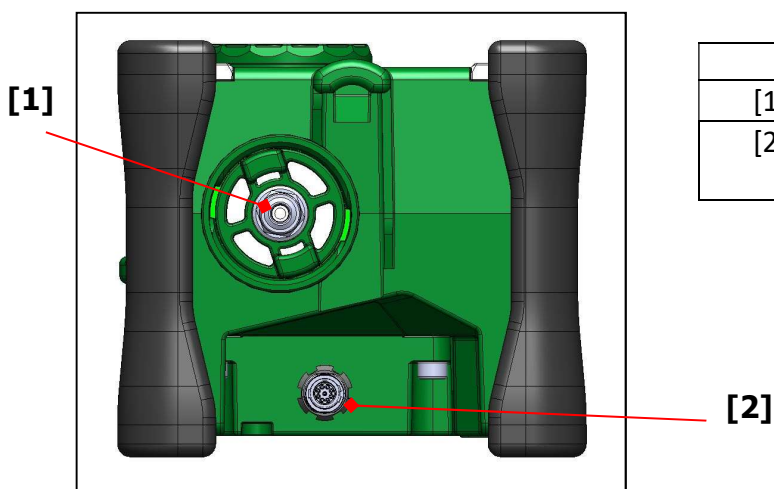

	Description
[1]	Gas Sample Inlet
[2]	Battery Charger / Data download Connector

4.3 Display

[A] [B] [C] [D]

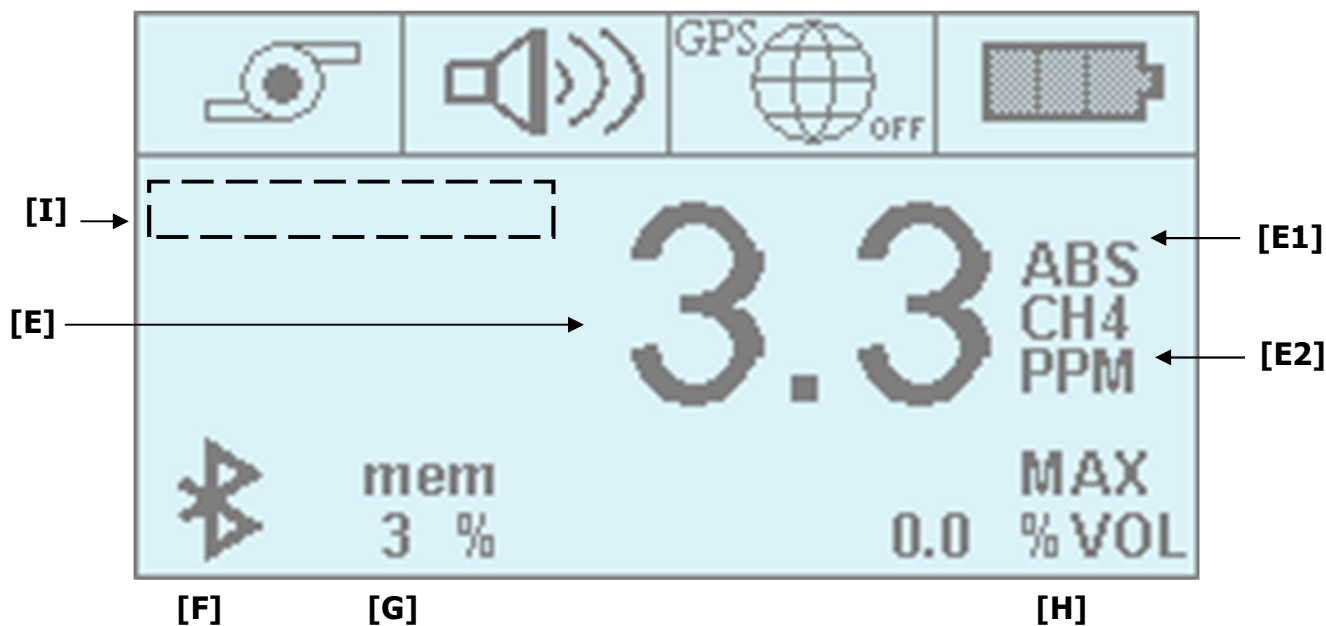

SECTOR	DESCRIPTION	PRESENT IN ALL VERSION OF LASER ONE
[A]	Pump status	YES
[B]	Buzzer status	YES
[C]	GPS status	NO
[D]	Battery status	YES
[E]	Measurement of Methane	YES
[E1]	Type of view: ABS (absolute) – REL (relative)	YES
[E2]	Unit of Measurement: PPM (parts per million) – % VOL (volume)	YES
[F]	Bluetooth enabled and active	NO
[G]	% of Memory Used	NO
[H]	Peak value over last 120 seconds	NO
[I]	Information (data download, test results etc.)	NO

NOTE: When the options C and F are not active, the icons associated with these options are not displayed.

The icons for G, H and I will only be displayed when the instrument is in logging mode.

4.4 Navigation System (menu)

Flow Diagram of the jogdial menu.

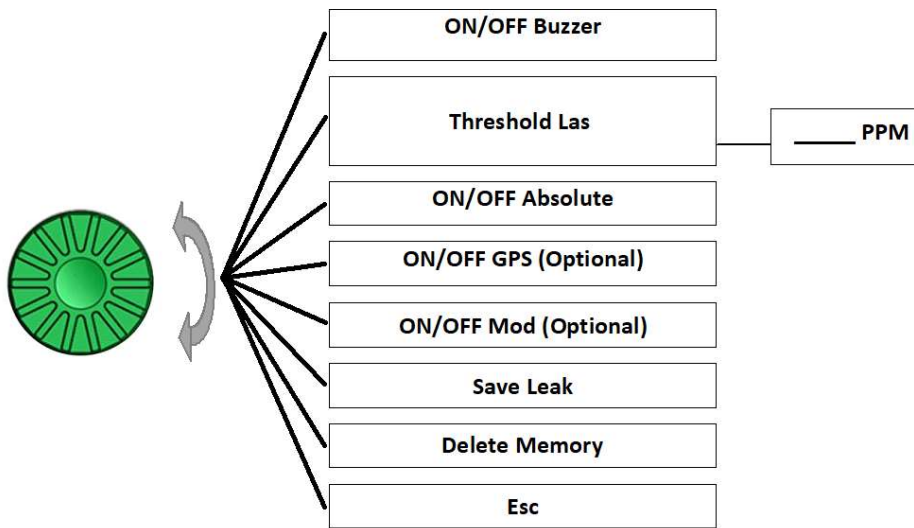

Push the jogdial and the menu will appear in the display window [E].

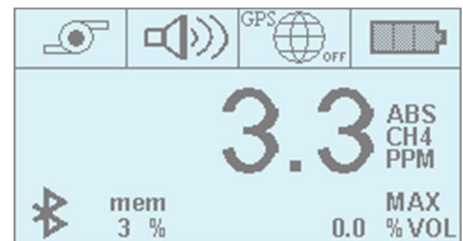

Rotate the jogdial to scroll through the available menu options. Once you have identified your desired option, push the jogdial to confirm your selection.

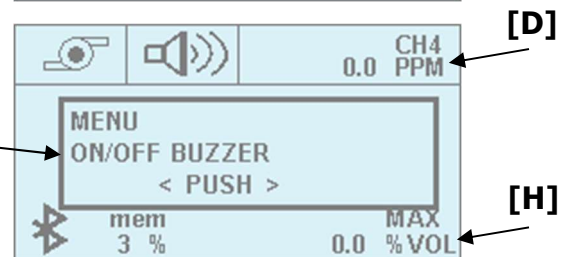

While a menu is active, the value of the gas is shown in the upper right corner and in the lower right corner of the display [D] and [H].

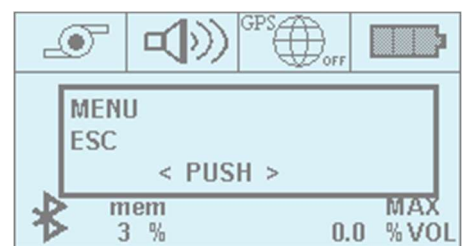

Select "ESC" to exit the Menu.

5 INSTRUMENT'S FUNCTION

5.1 Switching the instrument ON and OFF

5.1.1 Switch ON

Press the ON/OFF button for a few seconds, until the display is activated.

The start sequence includes several steps:

- Huberg logo.
- Firmware version of the instrument, detector board information, instrument serial number and next calibration date.
- Current date / time and next calibration.

If there is data stored in the instrument, you will see the message "DATA TO DOWNLOAD". In order to download the data, the ProSoft software must be used.

The instrument will warm up and self-calibrate. The warm up will last approximately 20-seconds and during this time, the instrument's functions are not available for use.

Once the warm up and calibration are complete, the four LED lights will blink and the alarm will sound.

The LASER ONE is now ready for use.

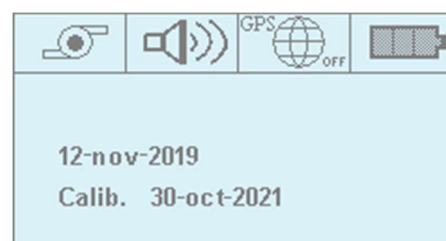
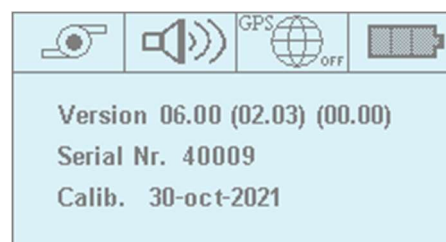

5.1.2 Switch OFF

To switch off the instrument, press and hold the ON/OFF button for a few seconds. A shut off message will appear on the display and a timer will count down. Once the counter starts to count down the button can be released.



6 START SURVEY

6.1 Use of GPS (Optional)

After switching the instrument on, the GPS will not be active.

The integral GPS allows the user to save the measured gas level with current GPS coordinates. The available memory installed in the instrument will give the user the facility to store a full day of measurements, it can record up to 8 hours. The GPS information is stored every second.

Note: Data is only acquired and saved when the GPS is active.

NB: ---- % means that the instrument is not logging.





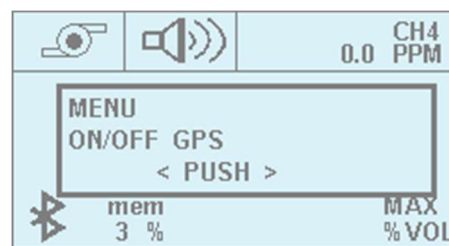

6.1.1 GPS Activation

To activate the GPS, press the Jogdial and rotate the dial to scroll through the menu options until "ON/OFF GPS" appears. Press the jogdial to confirm the selection. The GPS icon will change status from "Off" to "Active".

The percentage of memory used will also be displayed in the bottom left-hand corner.



Initially, only the percent symbol, (%), will be displayed. Once the GPS has stabilized and the LASER ONE begins saving data, a number will appear next to the percent symbol to indicate what percentage of the memory has been used.

Icon	Description	Icon	Description	Icon	Description
 Or 	GPS active but waiting for signal	 Or 	GPS off	 Or 	GPS active

The GPS module is a high-performance receiver with the ability to track up to 20 satellites. The antenna is a standard, high gain, vehicular type that provides quality tracking performance.

Start-up time for the GPS module can vary according to the strength of the actual signal received. The presence of high trees or buildings, aerial power lines or other obstructions will affect the signal. Typically, in an open area, the GPS will obtain a fix in less than a minute.

Note:

In the event of signal loss during the survey, the instrument will continue to log gas values and will associate the last saved tracked GPS position.

6.2 Saving leaks

To save a leak into the memory of the instrument, push the jogdial and rotate it until the Menu "Save Leak" appears. Push the jogdial to save the leak.

This operation is possible only if the GPS is on.

6.3 Delete data

To delete the data stored in the instrument, press the jogdial and rotate it until the menu displays DELETE MEMORY. Press the jogdial to confirm the selection.

Please Note: There is no secondary confirmation that you want to delete data.

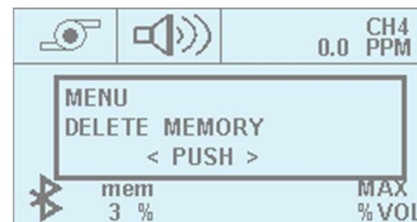

6.4 Description of the pneumatic circuits

The LASER ONE samples using a membrane pump. The typical flow is 0.8 l/m and the minimum flow is 0.7 l/m.

The use of accessories, such as the probes can slightly reduce this flow. It is advised to only use the parts and accessories supplied by QED Environmental Systems Limited.

The sample inlet port is suitable for a tube with the dimensions ID2mm X OD4 mm.

An internal hydrophobic filter protects the device against any ingress from dust or water. An additional external filter is also recommended which can help protect the internal filter.

 Warning	<p>The Hydrophobic filter is not design to filter anything other than water or moisture; chemicals may damage the efficiency of the filter.</p> <p>Please be vigilant when completing a survey and avoid sampling dust and moisture, as if the filter is too saturated it, may result in serious damage to the internal sensors.</p>
--	--

6.4.1 Malfunction of the pneumatic circuit / Pump OFF

The instrument detects when the pump flow is within normal operating parameters.

If the flow reduces below certain limits, the pump will stop, the LEDs will light up, the pump icon will have a 'X' overlay and the message "PUMP ERROR" will be displayed.

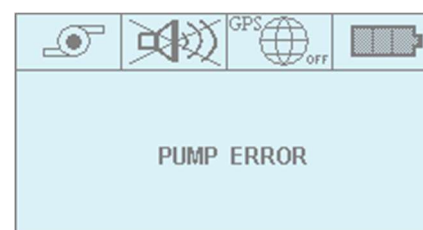

To toggle the sample pump between its 'on' and 'off' state, press the Function button.



When off, the pump icon will have a 'X' overlay and the main display (and '%LEL') will show four horizontal lines.

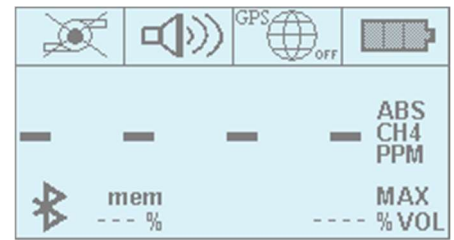

<p> Warning</p>	<p>The ingress of water or impurities may cause the malfunction of the pneumatic circuit and in some cases the damage to the sensors.</p>
<p> Warning</p>	<p>If the sampling is interrupted or suspended by the pump being turned off, the instrument will stop logging and horizontal lines (" - - -") will appear adjacent to the memory capacity percentage.</p> <div data-bbox="880 719 995 788" style="text-align: center;"> </div>

6.4.2 Restarting the pump operation

To turn the pump ON, press the Function button, the pump will restart and the 'X' overlaying the pump icon will disappear.



6.5 Saving leaks

To end the detection survey, manually stop the GPS or simply turn the instrument off.

7 SETTINGS

7.1 Measurement Range

7.1.1 Methane measurement

The LASER ONE measurement will be displayed on the main screen

The LASER ONE measurement is selective to Methane only and will not suffer from any cross-gas contamination from other gases due to the Laser Diode technology used.

The dual range will display the measured Methane from 0-1% in ppmVol (0- 10,000ppm) and above 1% will automatically switch to display the measurement in %Vol up to the full-scale of 100%.

7.1.2 Measure in absolute mode (ABS) and relative mode (REL)

The 'Absolute' measurement (ABS), is the measurement of the ambient concentrations which will include the background level of Methane present in the atmosphere, this is typically between 1.0 and 3.0 ppm.

It may be desirable for the user to remove this background level of Methane during the measurement survey. The 'Relative' measurement (REL) allows for the user to see more easily a change in the environmental concentration, it may also make a transient leak of gas more visible to the user as it would act as a contrast between the ambient concentration and the magnitude of the leak.

When the instrument is in 'Relative' (REL) mode, if the detected measurement exceeds a pre-defined value of 5ppm, the instrument will automatically switch to 'Absolute' (ABS) mode. When the measurement returns to a lower value (i.e. <5ppm), the instrument will automatically switch back to 'relative' (REL) mode.

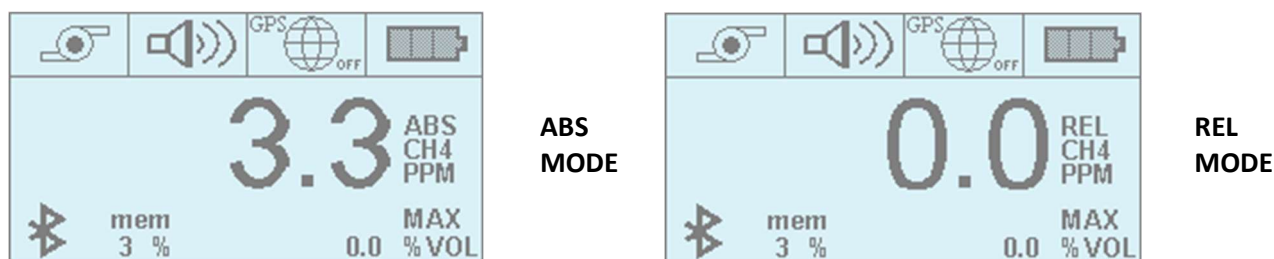

Note: The configuration or settings of the instrument when it is turned off will be remembered and returned to automatically when next used.

7.2 Setting the alarm threshold

The alarm threshold can be changed to best suit the application requirements: the minimum permissible alarm threshold is 1 ppm.

Push the jogdial to display the menu. Rotate the jogdial until the menu item "Threshold LAS" is visible then push the jogdial to select this option.

When in the "Alarm threshold" menu, change the ppm threshold by rotating the jogdial to increase or decrease the value.

To confirm the threshold level, push the jogdial.

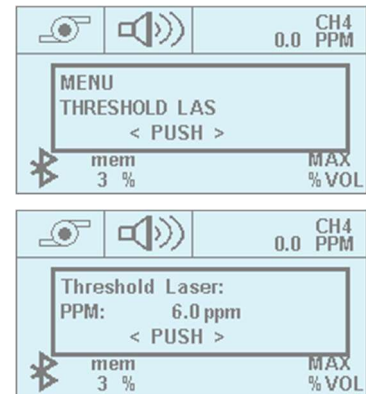

7.3 Acoustic and visual alarm

When the instrument is powered on, or if a gas measured exceeds the alarm threshold, an alarm will sound and the LED's will flash.

To disable or enable this alarm setting, push the jogdial, the option for 'Buzzer' is displayed.

Push the jogdial to either disable or enable the Buzzer.

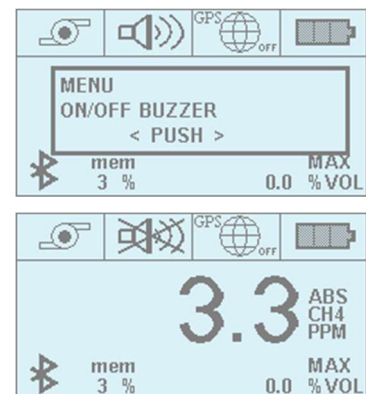

7.4 Backlight - Display illumination

To change the display illumination, push the 'on/off' button until you reach the desired illumination. The display has 4 levels of illumination.

7.5 Bluetooth description (OPTIONAL)

If the Bluetooth option has been fitted, the connectivity will always be active and a Bluetooth icon will be displayed on the main screen.

7.6 Recharging the Battery Pack

The LASER ONE (SEM5000) is supplied with its rechargeable battery pack (PBLO.NNNN.YY 3,7V 4Ah Code 205014). The charging of the battery is done only using the external adapter CCL0 (code 100189) and the power supply (Code 423007). Connect the charger with the power supply according the figure below, using the two polarity connectors in conformity with the maximum authorized voltage U_m equal to 15V.

The battery charge cycle typically takes 4.5 Hrs, a red led will be on during the charge cycle which when complete will change to green to indicate a full charge. The battery level indicator on the LASER ONE consists of three segments, the last of which indicates that there is approximately 30 minutes of power remaining.

The typical operational time from a full charge is 10 hours at an ambient temperature of 20°C and with the backlight ON.

Advice about the use of lithium ion technology:

In order to optimize the use and the lifetime of your battery, please, follow the following guidelines:

- Charge the battery with a temperature between the range [+10°; +30°C]
- Allow the battery to reach a complete discharge as frequently as possible
- Store in a dry place at a temperature preferably not exceeding 30°C

Central supply connector – $U_m=15V$.



Prosoft Comms

For Service Only

Warning: Do not charge the device in a hazardous area OR only charge in a non-hazardous, safe area.

8 MAINTENANCE

8.1 Replacing the Battery Pack

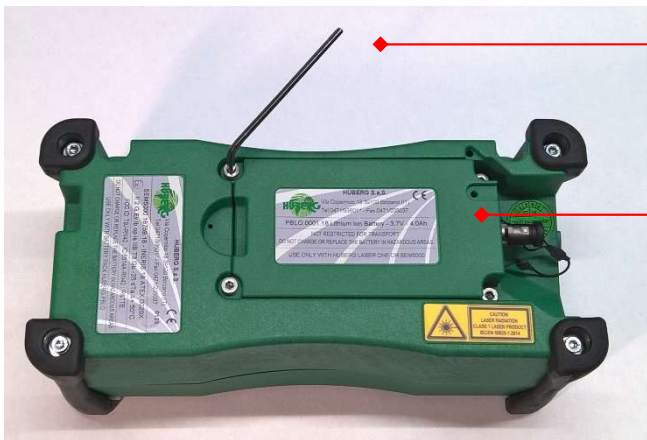

Allen Key 3mm



Battery pack

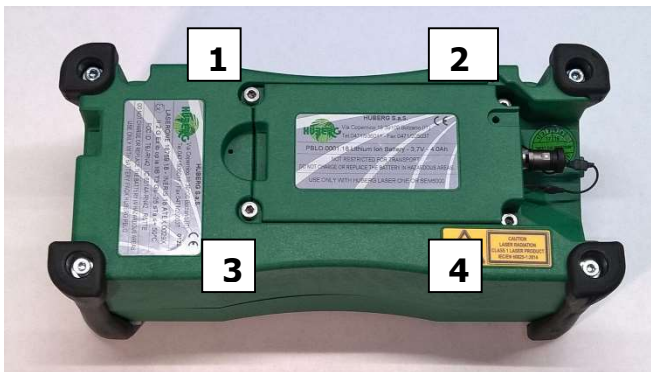

Unscrew the four screws

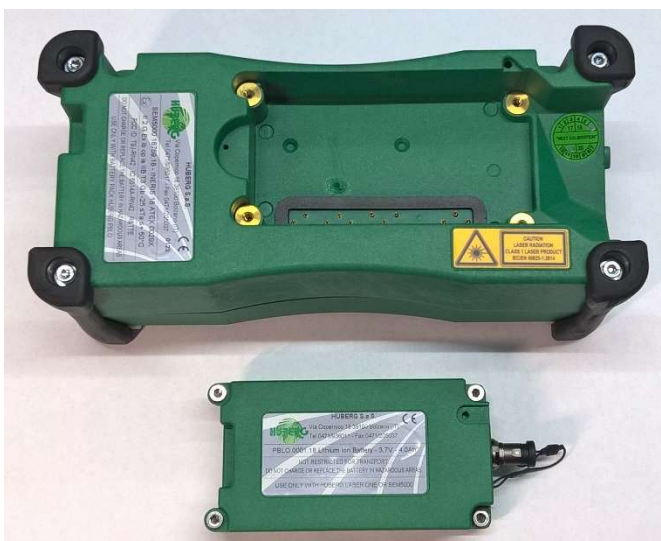

The picture shows the battery pack outside from its compartment.

⚠ Warning

Replace the battery pack only in a non-hazardous, safe area.

8.2 Replacing the Hydrophobic Filter



Unlock the filter by turning it counterclockwise and remove it.



Change the filter and reassemble by turning it clockwise.

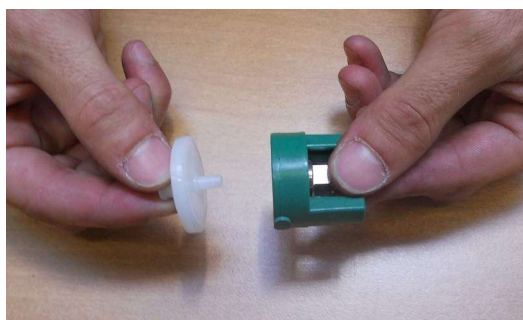

9 CH₄ ACCURACY TEST

The instrument can be tested with the test kit comprising of:

- The 10ppm cylinder
- Flow regulator 1l/min.

9.1 Service and Calibration

The LASER ONE should be regularly serviced. QED recommends that the instrument is calibrated on an annual basis.

NOTE: The next calibration date can be seen during the warm up sequence after powering the instrument and also on a label on the underside adjacent to the battery charging connector.

The hydrophobic internal filter should be checked periodically, (typically this will be weekly during periods of heavy use).

9.2 Alarms and Error Information

The table below gives the different alarm conditions or information about errors.

Displayed Alarm or Error	Error	Conditions
Acoustic alarm and the LED's flash	GAS alarm	Concentration measured above the alarm threshold.
The display shows the message ERROR PUMP, LED's flash and the pump icon is crossed	Pump stopped	The pump is stopped possibly due to the ingress of moisture or a high quantity of dust. -
Flashing battery icon	Battery level low	The lowest level of the charge capacity has been reached. There is approximately 30 minutes of use left (at +20°C)
LOW BATTERY message appears for a short duration	Battery level insufficient	The instrument is not able to work and switches off.
The display shows: no com from laser	Laser fails to communicate properly	Turn the instrument off and on again. If the error persists, contact technical@qedenv.co.uk
The display shows: Laser sensor error 130	Laser fails to stabilise properly	Turn the instrument off and on again. If the error persists, contact technical@qedenv.co.uk
The display shows: Laser sensor error 135	Laser fails to stabilize properly	Turn the instrument off and on again. If the error persists, contact technical@qedenv.co.uk
The display shows: Laser sensor error 150	Laser fails to stabilize properly	Turn the instrument off and on again. If the error persists, contact technical@qedenv.co.uk
The display shows: Laser sensor error 142	Laser fails to stabilize properly	Turn the instrument off and on again. If the error persists, contact technical@qedenv.co.uk
The display shows: Laser sensor error 144	Laser fails to stabilize properly	Turn the instrument off and on again. If the error persists, contact technical@qedenv.co.uk

Resetting the alarms:

The table below indicates if it is possible or not to acknowledge and reset the alarm or information of default when the device is in operation.

Alarm information	Possibility of Reset
Threshold of concentration	Sound alarm: YES
	Flashing red Led: NO
Pump stopped	Display indicator: NO
Battery level low	Display indicator: NO

This section outlines various warning and error messages which the operator may receive during general operation of the instrument. For further assistance please contact Technical Support at QED on +44(0)333 800 0088 or email technical@qedenv.co.uk.

10 WARRANTY

QED will repair or replace (at QED's discretion) any goods supplied by the company in respect to defects arising within **12 months** from date of purchase or delivery, whichever is later, provided that:

- The model is a LASER ONE gas analyser.
- The defect is due to faulty parts or workmanship provided by QED.
- Proof of delivery/purchase must be provided to QED for any claims. This includes a QED sales order, invoice, or delivery note.
- All warranty repairs can only be carried out by QED or its authorised agents. In certain circumstances, permission may be granted by QED for the owner to replace a supplied part under warranty.
- Any repair or replacement component under warranty will not extend the warranty period of the analyser.
- Products must have been returned for service and calibration as recommended by QED as per the individual operating manual.
- Where replacement parts have been supplied by QED under warranty, the replaced parts must be returned to QED. If not returned, QED reserve the right to charge for the replacement part.
- If no fault is found an investigation charge may apply.
- QED's Technical Support MUST be notified in the event of a pending warranty claim. They will then issue a returns reference number that must be included in any return. Failure to provide this will void any warranty claim.

The following is not included:

- Normal wear and tear of parts that might wear out over time, or be consumed, is not covered. Parts not covered include, but not limited to the PTFE filter and tubing.
- A service is not part of a warranty claim.
- Accidental damage, including dropping during use.
- Damage as a result of vandalism.
- Faults arising from use of the equipment that is not in accordance with standard operating procedures laid out in QED's operating manual.
- Faults arising from use of the equipment in unsuitable applications.
- Repairs or alterations carried out by parties other than QED, its authorised agents, or under the instruction of QED.
- Any data stored on the equipment that may be lost.
- A claim due to a failure in maintaining the analyser in accordance with the operating manual.
- A claim as a result of poor quality or inadequate repairs.
- Any business-related losses such as income, profits, and contracts (as far as the law allows).

The following voids the warranty:

- When non-approved QED parts have been used for repair or maintenance.
- When parts are added, or alterations made, to the analyser outside the scope of the operating manual.
- The analyser has been opened, unless by QED approved service centres (where applicable).
- The equipment has been stored or installed outside of the operating range and environmental conditions determined in the operating manual.
- The equipment has not been maintained in accordance with the operating manual.

Service Warranty:

- QED offer a three-month warranty period, following a QED service, to cover any defects that have arisen because of that service.

**Note**

Warranty repair is only granted after an investigation by QED.

For assistance in determining if your equipment qualifies for warranty investigation, please contact your local distributor, or our technical support team at QED on +44(0)333 800 0088 or email technical@qedenv.co.uk.

For extended warranty options, please contact your local distributor, or our sales team at QED on +44(0)333 800 0088 or email sales@qedenv.co.uk.

For any other queries please contact your local distributor, or our sales team at QED on +44(0)333 800 0088 or email sales@qedenv.co.uk.

QED Environmental Systems reserve the right to update these terms and conditions without notice.

Important:



Please read the instruction manual before using the LASER ONE instrument to ensure all aspects are understood before completing any survey missions.

Any guarantee may be compromised if the LASER ONE instrument is not handled correctly or damaged as a result of improper use.

Note:



QED Environmental Systems Ltd is constantly committed to develop and improve its products and will not accept any liability for any modification carried out on this equipment.



If the LASER ONE is serviced by unqualified engineers the ATEX certification may be invalidated and the instrument may be unsafe for use in a potentially explosive atmosphere.

11 ACCESSORIES

107034	4091016	4091014	107048	422097
				
Hard Carry Case	Carrying strap for Laser One with 2 securing points.	Carrying strap for Laser One and PC with 4 securing points	Laser One Pouch with waist strap	Panasonic tablet for use with Laser One
422099	107041	423007	100189	102010
				
FireHawk tablet for use with Laser One	Panasonic carry case FZG1	Power supply Laser one ATEX	Charger CCLO for the LASER ONE ATEX	Car cable power supply LASER ONE ATEX
900011	100060	100157	507103	402004
				
Suction Probe	Carpet probe	On demand pressure regulator	Gas check cylinder – Methane 10ppm	Dust filter for probes Package of 10 pcs.
414033	402030	402035	201261	205014
				
Pipe replacement for probe with adapter diameter 4x2. 100m reel	Anti-water filter 25 mm PTFE 0,45 um -to be insert into the aluminium support with the Leur connector	Anti-water filter 60 mm PTFE 0.45 um –inserted in tubes of probes, to protect against moisture ingress	Dust filter kit (25pcs) General purpose acetate probes	Battery PBLO Laser one Atex complete with hexagonal key

12 APPENDIX A – SAFE USE OF THE INSTRUMENT

The information contained in these safety instructions must be followed in addition to the warnings in the user manual supplied to the customer.

- Do not use the LASER ONE in a classified area if the protection concepts of the device do not meet the requirements of the Zone. It is the user's responsibility to determine the suitability of the product for their application.

12.1 Laser radiation

The instrument LASERONE contains an invisible laser source. The instrument is classified Class 1 according European standards.

- Do not open the device



12.2 Other precautions for the usage

- The charging of the batteries must be in a safe place with the appropriate external adapter.
- The instrument is dedicated to measurements in ambient air or can accept gas mixtures containing non-corrosive chemical products. In the event that other gases other than Hydrocarbons or Inert gases, please contact your QED distributor to verify the compatibility with the device.

12.3 Testing and maintenance

THE CHECKS AND MAINTENANCE OF CERTIFIED EQUIPMENT SHOULD BE PERFORMED ACCORDING TO THE CRITERIA OF THE STANDARD EN60079-17

12.4 Repair

In the event of malfunction or damage, please contact QED (or an authorised distributor) for support.

13 APPENDIX B – TECHNICAL SPECIFICATION

Target gas	Methane. The instrument is selective to the methane.
Measurement ranges	1-10,000ppm 0,1% - 100% v/v (option)
Sensitivity	1ppm
Threshold of sensitivity	0.3ppm
Accuracy	+/-0.7ppm for [1: 10ppm] +/-10% relative up to 10,000
Response time	T90 = 2.5s T90 = 3.5s with probe
Environmental working conditions	Humidity: 5% to 80% relative humidity Temperature: -25°C to +50°C In a non-condensing atmosphere Pressure: Atmospheric pressure 800mbar to 1100mbar
Power supply	Specific Li ion rechargeable battery pack 3,7V – 4000mA/h Recharging duration: 4h30min
Battery life	10 hours at 20°C (with backlight activated) 8 hours at extreme temperatures with backlight activated
Case	Carbon reinforced polyamide with fiberglass Dimensions: L x w x h = 229 x 97 x 109mm Weight: 1.3Kg (in operation)
Protection level	IP65
Environmental storage conditions (excluding batteries)	Humidity: < 95% relative humidity Temperature: -40°C to +60°C
Sampling flowrate	0.8 l/min.; [0.6; 1l/min.]
User interface	Large Display: matrix of 240x128 Jogdial: Scroll menu for a rapid and easy selection 3 Keys for a direct activation of the functions
Alarms	Threshold of the Methane concentration Pump flow fail
Sound level of the buzzer (30cm)	85 dB (A)
Status Indicators	Measurement mode Battery level Pump Communication
Electrical connections	Multiplug for battery charger and for a communication with a computer. Equipped with a security ring.
Gas connections	Quick-connect gas inlet coupling with locking mechanism: Quick-connect gas outlet coupling.
Carrying Straps	Synthetic band, 30mm

14 APPENDIX C - INFORMATION ON DISPOSAL FOR USERS OF WASTE ELECTRICAL & ELECTRONIC EQUIPMENT

WEEE COMPLIANT



The wheeled bin symbol now displayed on equipment supplied by QED Environmental Systems Limited signifies that the apparatus must not be disposed of through the normal municipal waste stream but through a registered recycling scheme.

The Waste Electrical and Electronic Equipment directive (WEEE) makes producers responsible from July 1st 2007 in meeting their obligations, with the fundamental aim of reducing the environmental impact of electrical and electronic equipment at the end of its life.

QED is now registered with the Environmental Agency as a producer and has joined a recycling scheme provider who will manage and report on our electrical waste on our behalf.

When your instrument is at the end of its life, please contact the Sales team at QED who will advise you on the next step in order to help us meet our obligations.

15 APPENDIX D – BLUETOOTH MODULE COMPLIANCE

The Bluetooth module has a QDID registered with the Bluetooth SIG: QDID: B014867

15.1 United States

The device contains Transmitter Module FCC ID: T9J-RN42. This device complies with Part 15 of the FCC Rules. Operation is subject to the following two conditions: (1) this device may not cause harmful interference, and (2) this device must accept any interference received, including interference that may cause undesired operation.

This equipment has been tested and found to comply with the limits for a Class B digital device, pursuant to part 15 of the FCC Rules. These limits are designed to provide reasonable protection against harmful interference in a residential installation. This equipment generates, uses and can radiate radio frequency energy, and if not installed and used in accordance with the instructions, may cause harmful interference to radio communications. However, there is no guarantee that interference will not occur in a particular installation. If this equipment does cause harmful interference to radio or television reception, which can be determined by turning the equipment off and on, the user is encouraged to try to correct the interference by one or more of the following measures:

- Reorient or relocate the receiving antenna.
- Increase the separation between the equipment and receiver.
- Connect the equipment into an outlet on a circuit different from that to which the receiver is connected.
- Consult the dealer or an experienced radio/TV technician for help.

15.2 Canada

The device contains transmitter module IC: 6514A-RN42.

This device complies with Industry Canada license exempt RSS standard(s). Operation is subject to the following two conditions: (1) this device may not cause interference, and (2) this device must accept any interference, including interference that may cause undesired operation of the device.

Le présent appareil est conforme aux CNR d'Industrie Canada applicables aux appareils radio exempts de licence. L'exploitation est autorisée aux deux conditions suivantes : (1) l'appareil ne doit pas produire de brouillage, et (2) l'utilisateur de l'appareil doit accepter tout brouillage radioélectrique subi, même si le brouillage est susceptible d'en compromettre le fonctionnement.

Under Industry Canada regulations, this radio transmitter may only operate using an antenna of a type and maximum (or lesser) gain approved for the transmitter by Industry Canada. To reduce potential radio interference to other users, the antenna type and its gain should be so chosen that the equivalent isotropically radiated power (e.i.r.p.) is not more than that necessary for successful communication.

Conformément à la réglementation d'Industrie Canada, le présent émetteur radio peut fonctionner avec une antenne d'un type et d'un gain maximal (ou inférieur) approuvé pour l'émetteur par Industrie Canada. Dans le but de réduire les risques de brouillage radioélectrique à l'intention des autres utilisateurs, il faut choisir le type d'antenne et son gain de sorte que la puissance isotrope rayonnée équivalente (p.i.r.e.) ne dépasse pas l'intensité nécessaire à l'établissement d'une communication satisfaisante.

15.3 Europe

The Bluetooth module has been tested to R&TTE Directive 1999/5/EC Essential Requirements for Health and Safety (Article (3.1(a)), Electromagnetic Compatibility (EMC) (Article 3.1(b)), and Radio (Article 3.2) and are summarized below:

Certification	Standards	Article	Laboratory	Report Number	Date
Safety	EN 60950-1:2006+A11:2009+A1:2010+A12:2011	[3.1(a)]	Worldwide Testing Services (Taiwan) Co., Ltd.	W6M21402-13966-L	2014-03-24
Health	EN 62479:2010			W6M21402-13966-62479	2014-03-13
EMC	EN 301 489-1 V1.9.2 (2011-09)	[3.1(b)]		W6M21402-13966-E-16	2014-03-13
	EN 301 489-17 V2.2.1 (2012-09)				
Radio	EN 300 328 V1.8.1 (2012-06)	(3.2)		W6M21402-13966-T-45	2014-03-13
Notified Body Opinion	CE0681	—	Eurofins Product Service GmbH	U9M-1404-3736-C-V01	2014-04-15



www.huberg.com

NEED HELP?



SCAN OR CLICK HERE
TO CONTACT US



Air-Met Scientific
www.airmet.com.au

Contacts:

SALES ENQUIRIES: sales@qedenv.co.uk

SERVICE & CALIBRATION ENQUIRIES: service@qedenv.co.uk

TECHNICAL SUPPORT: technical@qedenv.co.uk

INSTRUMENT HIRE: hire@qedenv.co.uk

WEBSITE: www.qedenv.com

Office:

QED Environmental Systems Ltd

Cyan Park - Unit 3

Jimmy Hill Way

Coventry

CV2 4QP

UNITED KINGDOM

Tel: +44 (0)333 800 0088