

NEED HELP?

SCAN OR CLICK HERE
TO CONTACT US



Air-Met Scientific
www.airmet.com.au

VENTIS[®]
MX4

Product Manual

Set-up
Operation
Service



Part Number: 17152357-1
Edition 17

**INDUSTRIAL
SCIENTIFIC**

www.indsci.com

Contents

▶ Copyright Notice	1
▶ Warnings and Cautionary Statements.....	1
General.....	1
Personnel	1
Hazardous Conditions, Poisons, and Contaminants	1
General Usage	2
Agency-issued Conditions of Use and Warnings.....	2
Recommended Practices	3
▶ Ventis MX4 Resources	3
▶ Ventis MX4 Capabilities.....	3
▶ Unpacking the Monitor.....	4
Contents	4
Hardware Features and Functions.....	5
Display Screen	6
Alarms	8
▶ Monitor Set-up	12
Batteries	12
Docking Stations, Chargers, and other Accessories	12
Battery Charging	13
Power-on and -off.....	13
Configuration	15
Instructions	15
Zero, Calibration, and, Bump testing	24
Procedures.....	24
Recommendations	24
General information.....	25
Instructions	25
Supplies.....	26
Remote Sampling.....	32
Cleaning	33
Service	33
Aspirated Monitor	34
Diffusion Monitor	35

Sensor, Sensor Barrier, LCD, and vibrating motor replacement	37
Battery Configuration	40
► Products, Specifications, and Certifications	42
Ventis MX4 Accessories and Parts	42
Monitor Specifications	43
Battery Specifications	43
Operating Conditions	43
Cold-weather Operation	44
Storage Conditions	44
Sensor Specifications	44
Toxic Gas Sensor Cross-sensitivity Table	45
LEL, and LEL Correlation Factors for Combustible Gases	46
Certifications	47
Marking Requirements	49
► Warranty	50
Limitation of Liability	50
Contact Information	51

► Copyright Notice

Ventis® MX4 and Ventis® are registered trademarks of Industrial Scientific Corporation.









All trademarks and registered trademarks are the property of their respective owners.















These help materials or any part thereof may not, without the written consent of Industrial Scientific Corporation, be copied, reprinted, or reproduced in any material form including but not limited to photocopying, transcribing, transmitting, or storing it in any medium or translating it into any language, in any form or by any means, be it digitally, electronic, mechanical, xerographic, optical, magnetic, or otherwise.









The information contained in this document is proprietary and confidential and all copyright, trademarks, trade names, patents, and other intellectual property rights in the documentation are the exclusive property of Industrial Scientific Corporation unless otherwise specified. The information (including but not limited to data, drawings, specification, documentation, software listings, source or object code) shall not at any time be disclosed directly or indirectly to any third party without prior written consent.

The information contained herein is believed to be accurate and reliable. Industrial Scientific Corporation accepts no responsibility for its use by any means or in any way whatsoever. Industrial Scientific Corporation shall not be liable for any expenses, costs by damage that may result from the use of the information contained within this document. Although every effort is made to ensure accuracy, the specifications of this product and the content herein are subject to change without notice.

► Warnings and Cautionary Statements

General	
	IMPORTANT: Failure to perform certain procedures or note certain conditions may impair the performance of this product. For maximum safety and optimal performance, read and understand the Ventis MX4 Product Manual available online at the Ventis MX4 Resource Center: www.indsci.com/VentisMX4resources .
Personnel	
	CAUTION: For safety reasons, this equipment must be operated and serviced by qualified personnel only. Read and understand the product manual completely before operating or servicing.
Hazardous Conditions, Poisons, and Contaminants	
	WARNING: Servicing the unit, replacing or charging batteries, or using the communications port must only be done in an area known to be nonhazardous. Not for use in oxygen-enriched atmospheres.
	WARNING: Power-off the monitor before servicing the unit or replacing the battery.
	WARNING: Substitution of components may impair intrinsic safety and may cause an unsafe condition.
	CAUTION: High off-scale readings may indicate explosive gas concentration(s).
	CAUTION: Any rapid up-scale reading followed by a declining or erratic reading may indicate gas concentration(s) beyond the upper scale limit which may be hazardous.
	Silicone compound vapors or other known contaminants may affect the combustible gas sensor and cause readings of combustible gas to be lower than actual gas concentrations. If the monitor has been used in an area where silicone vapors were present, always calibrate the monitor before next use to ensure accurate measurements.
	Do <i>not</i> use the <i>Ventis Slide-on Pump (VSP)</i> when sampling for these target gases: Chlorine (CL ₂), Chlorine Dioxide (CLO ₂), Hydrogen Chloride (HCL), and volatile organic compounds (VOC), or when a sensor for any of these gases is installed and the target gas is unknown; use only the <i>Ventis MX4 Pump Module</i> . The use of the VSP with these gases will result in inaccurate gas readings due to their susceptibility to absorption.

General Usage	
	Oxygen-deficient atmospheres may cause combustible gas readings to be lower than actual concentrations.
	Oxygen-enriched atmospheres may cause combustible gas readings to be higher than actual concentrations.
	Sudden changes in atmospheric pressure may cause temporary fluctuations in the oxygen reading.
	Verify the calibration of the combustible gas sensor after any incident where the combustible gas content has caused the monitor to display an over-range condition.
	Sensor openings, water barriers, and the pump inlet must be kept clean. Obstruction of the sensor openings or pump inlet and/or contamination of the water barriers may cause readings to be lower than actual gas concentrations.
	To avoid the potential of liquid being pulled into the sample tubing and pump assembly, it is recommended that Industrial Scientific filter (P/N 17027152) be used on the sample tubing when drawing samples using the aspirated monitor.
	WARNING: INSERT THE ALKALINE BATTERIES WITH THE CORRECT POSITIVE “+” AND NEGATIVE “-” ORIENTATION. WARNING: The Ventis MX4 is only approved for use with AAA battery types Energizer EN92 and Duracell MN2400. Do NOT mix battery types.
	To avoid potentially inaccurate readings for some applications with diffusion instruments—monitoring for gases other than O ₂ , CO, CO ₂ , H ₂ S, and combustible gases [LEL/CH ₄] <i>—only</i> use a leather case as a carrying case. Do not power on, operate, or power off the instrument while it is in a leather case.
Agency-issued Conditions of Use and Warnings	
	Ensure all part-use restrictions (e.g., battery) meet any agency-mandated conditions of use.
	Ensure all instrument-configurable settings (e.g., always-on setting) meet any agency-mandated conditions of use. When using instrument-compatible Industrial Scientific docking stations, maintain mandated settings through the software (e.g., iNet Control or Accessory Software) or by manually configuring the instrument settings after docking.
	The Ventis MX4 is CSA certified according to the Canadian Electrical Code for use in Class I, Division 1 and Class I, Zone 1 Hazardous Locations within an ambient temperature range of T _{amb} : -20°C to +50°C. CSA has assessed only the %LEL combustible gas detection portion of this instrument for performance according to CSA Standard C22.2 No. 152. This is applicable only when the monitor is used in the diffusion mode and has been calibrated to 50% LEL CH ₄ , and when the monitor is used in the aspirated mode with an Extended range lithium-ion battery and has been calibrated to 50% LEL CH ₄ .
	CAUTION: CSA C22.2 No. 152 requires before each day’s usage, sensitivity must be tested on a known concentration of pentane or methane equivalent to 25% or 50% of full scale concentration. Accuracy must be within -0% to +20% of actual concentration. Accuracy may be corrected by referring to the zero/calibration section of the Product Manual.
	The equipment complies with the standards IEC 60079-29-1 and EN 60079-29-1 for methane, propane, and hexane with the following exception: as for the methane (mine) detector, the battery run time was verified to be seven (7) hours rather than the eight (8) hours recommended by the standards, respectively.
	The Mine Safety and Health Administration (MSHA) has approved the Ventis MX4 as a Permissible Multi-Gas Monitor with the following warnings: <ul style="list-style-type: none"> • MSHA approved for use with either the P/N 17134453-X2, 3.7 volt, Lithium-ion battery or P/N 17148313-2, 3.7 volt, lithium-ion Extended battery only. The battery pack is not user-replaceable. The monitor battery and the lithium battery on the main PCB are technician replaceable only. Charge rechargeable lithium-ion batteries with an Industrial Scientific battery charger designed for use with this monitor in fresh air locations only. • The monitor is to be calibrated according to the procedures in the instruction manual only. • The aspirated version of the Ventis MX4 is only approved for use with the Extended range battery. • The monitor must display methane in the percent-by-volume mode (0-5%) for compliance determinations required by 30 CFR Part 75, subpart D.

	<p>SANS 1515-certified units may be used only as follows:</p> <ul style="list-style-type: none"> • Diffusion applications • Configured and maintained to disallow power-off when the unit is in alarm. • The Methane alarms are set as follows: low alarm = 1 %vol and high alarm = 1.4 %vol. • With approved Lithium-ion batteries (see Ventis MX4 Accessories and Parts in this manual).
Recommended Practices	
	<p>Industrial Scientific Corporation recommends the monitor be fully charged (when equipped with a rechargeable battery), configured, and calibrated before first time use. If the lithium-ion battery is deeply discharged, it can take up to an hour for the instrument display to indicate that the battery is charging. Monitors used infrequently should be fully charged every four months.</p>
	<p>No part of the unit should be covered by any garment, part of a garment, or other item that would restrict the flow of air to the sensors or impair the operator's access to the audible, visual, or vibration alarms.</p>
	<p>Industrial Scientific Corporation recommends a full monitor calibration be performed monthly (at a minimum), using a certified concentration(s) of Industrial Scientific calibration gas(es) to help ensure monitor accuracy.</p>
	<p>Industrial Scientific Corporation recommends the monitor be zeroed and bump tested before each use with a certified concentration(s) of Industrial Scientific calibration gas(es).</p>
	<p>Battery contacts are exposed on batteries when they are removed from the monitor. Do not touch the battery contacts and do not stack batteries on top of one another.</p>
	<p>When reassembling the instrument or installing a battery pack, maintain ingress protection by tightening each fastener to its stated torque value (see the Ventis MX4 Monitor disassembled view diagram and its parts list in this manual).</p>
	<p>Contact your service representative immediately if you suspect that the Ventis MX4 is working abnormally.</p>

► Ventis MX4 Resources

The Ventis MX4 Product Manual is the primary resource, within a full suite of learning tools, developed for the monitor user. Its step-by-step “walk through” format covers everything from unpacking to set-up, operation, and service. **All Ventis MX4 users should read and understand the Product Manual** prior to unpacking or using the monitor.

Ventis MX4 product-specific resources are part of the organization's broader *training* line-up, featuring online training modules and face-to-face classroom programs for technicians, operators, first responders, trainers, and distributors. Courses combine theory with hands-on learning and can be tailored to the customer's unique requirements and gas monitoring applications.

The organization's *customer and technical support* call centers provide product and order information, how-to product assistance, and guidance for in-depth technical applications. Its *service centers* offer comprehensive factory repair and maintenance services.

Industrial Scientific Corporation provides a full suite of resources to aid customers in the competent and safe use of its products and services. With 19 manufacturing, support, and service centers and hundreds of distributors worldwide, Industrial Scientific serves the globe's gas detection needs.

► Ventis MX4 Capabilities

The Ventis MX4 is a *portable* multi-gas monitor. Offered as a *diffusion* monitor, it detects and measures gas(es) present in open space. To enable monitor use within confined space locations, the Ventis MX4 is also offered as an *aspirated* monitor. A pump module and battery accessories enable the conversion of either monitor for dedicated use in either confined or open spaces.

Based on the customer's monitor order, up to four sensors are factory installed enabling the monitor to continuously and simultaneously detect and measure the presence of up to four specific gases.

Sensor Category	Number available per monitor	Gases Monitored
Oxygen	1	O ₂ (Oxygen) only
Combustible	1	Monitor can be configured for sensor to measure ONE of the following: <ul style="list-style-type: none"> • LEL (Pentane) • LEL (Methane) • CH₄ (0%-5%)
Toxic	2	Each sensor detects and measures only ONE of the following: <ul style="list-style-type: none"> • CO (Carbon Monoxide) • CO/H₂ Low (Carbon Monoxide with low H₂ interference) • H₂S (Hydrogen Sulfide) • NO₂ (Nitrogen Dioxide) • SO₂ (Sulfur Dioxide)

Equipped with a multi-mode (audible, visual, and vibration) and multi-level *alarm system*, the Ventis MX4 monitor is capable of notifying its user of potentially hazardous gas concentrations.

The monitor performs continuous *data logging* at 10 second intervals. It can store approximately 90 days of data for a four-sensor configuration. Its date- and time-stamped event log records and stores data for the following: 60 alarm events, 30 error events, and 250 manually performed calibrations or bump tests. The memory, when full, overwrites the oldest data as the newest readings and events are logged.

The Ventis MX4 monitor functions as an independent device to monitor the environment for hazardous gas concentrations. It is compatible with products that charge, calibrate, bump test, read and record instrument data, protect, and otherwise enable or enhance use of the monitor and its data. For a complete list of these products, please refer to the manual section, [Ventis MX4 Accessories and Parts](#).

► Unpacking the Monitor

Contents

The instrument packaging contains the following items including, when ordered, those marked *optional*. Each item ordered should be accounted for in the unpacking process.

Quantity	Item	Notes
1 as ordered	Ventis MX4 Portable Multi-gas Monitor	The monitor type is indicated on the box label. Options: <ul style="list-style-type: none"> • Ventis MX4 Diffusion • Ventis MX4 Aspirated • Ventis MX4 Aspirated with Conversion Kit
1	Ventis MX4 Quick start guide	Review for important safety information before using the monitor.
1 installed as ordered	Battery	One of four battery types are factory installed as indicated on the box label. Options: <ul style="list-style-type: none"> • Rechargeable Lithium-ion (Li-ion) • Rechargeable Slim extended lithium-ion (Li-ion) • Rechargeable Extended range lithium-ion (Li-ion) • Replaceable Alkaline
1 as ordered	Ventis Charger	Universal power cord. AC charger products include interchangeable plugs (US, UK, EU, and AUS).
0 or 1	Calibration Cup	Diffusion – 1 included Aspirated – 0 included
1	Calibration and Bump Test Tubing	Diffusion – two feet of clear tubing

Quantity	Item	Notes
0 or 1	In-field Sampling Tubing	Diffusion – 0 included Aspirated – Ten feet of black tubing
1	Final Inspection & Test Report	Contains the following factory set* information: <ul style="list-style-type: none"> • Monitor Set-up Date • Monitor Part Number (P/N) • Monitor Serial Number (S/N) • For Each Sensor*: <ul style="list-style-type: none"> • P/N • S/N • Type • Location • Alarm level values • Span gas values • Span reserve values <p>*Some factory set sensor values subject to user changes.</p>
1	Warranty Card	--

After unpacking, if any item is missing or appears to have been damaged, contact a local distributor of Industrial Scientific products or Industrial Scientific Corporation (See [Contact Information](#) for details).

► Monitor Overview

Hardware Features and Functions

The monitor's *case top* (front of monitor) has two main sections. As shown below, the upper section contains the sensor ports. The lower section houses the user interface features, an *LCD display screen* and two *buttons*. Each feature's general functions are noted below. As shown, the diffusion and aspirated monitors differ with respect to the location of the air intake mechanism and visual alarm indicators.

The instrument may be used in any orientation when clipped to the user or with a compatible carrying case. Normal instrument orientation for measuring gas concentration is hand held with sensors and display facing the operator.



Number	Feature	Functions
1	Visual alarm indicator	Signals an alarm or warning; frequency varies by alarm level. Also used as a confidence indicator.
2	Pump inlet (aspirated) Sensor ports (diffusion)	Air intake; calibration and bump test gas intake.
3	LCD display	User interface; backlight flashes when monitor is in system, high, or low alarm states.
4	Audible alarm ports	On when monitor is in system, high, or low alarm states; frequency and tone vary by alarm level. Also used for warnings and as confidence indicator.
5	On/Off/Mode button	Used to power-on and power-off. Also used to bypass a process/step or advance to a next screen in both gas monitoring and configuration modes. Sets values in configuration mode.
6	Enter button	Used to begin a process/step in a process. Edits values in configuration mode.
7	IrDA interface	Indicates infrared light data exchange in-progress.
8	Charging contacts	Battery charging.

Display Screen

The Ventis MX4 *Boot-up Screen*, as shown below, serves to introduce all icons and the alpha-numeric items (e.g., 8.8.8) that can appear on the display when the monitor is in use, docked, or charging. Each display item is stationary, communicates unique information, and appears only when relevant to the task being performed.



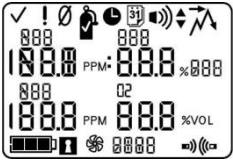
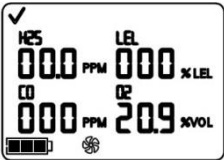



A sample *Gas Monitoring Screen* is also shown below, next to the boot-up screen. This illustrates how the icons and the alpha-numeric characters work together to communicate several points of information to the monitor user.

 <p>Boot-Up Screen All possible screen images.</p>	 <p>Gas Monitoring Screen Sample screen in gas monitoring mode.</p> <p><i>Note:</i> Display screens featured throughout this manual include the “pump” icon. Similar in appearance to a fan, it indicates an aspirated monitor is in use. For a diffusion monitor, the pump icon does not appear on the display.</p>
--	--

It is helpful to view the boot-up screen in sections. The top and bottom rows each contain icons. The main function of the middle section, in *gas monitoring mode*, is to communicate gas concentration readings. Definitions for all icons, gas name abbreviations, gas measurement units, and other indicators are provided below. Where applicable, display variations are noted.

Top Row Icons	Definition
✓	Status: indicates no monitor or sensor faults.
!	Warning: indicates monitor or sensor fault.
∅	Zero: communicates zero status (e.g., zero results, zero in-progress, etc.).
	Gas Cylinder: communicates calibration related information (calibration due, calibration apply gas, etc.).
	Clock: indicates a process is in-progress.
	Calendar: communicates overdue warnings for service items (calibration, bump testing, etc.).
	Alarm: indicates an alarm causing condition.
	Low level audio alarm is on.
	High level audio alarm is on.
	Peak: displayed when peak detection values are viewed.

Alpha-numeric display values	Definition
CO	Carbon Monoxide (CO)
CH4	Methane (CH ₄)
SO2	Sulfur Dioxide (SO ₂)
LEL	Lower Explosive Limit. Display variations: “LEL” (English) “LIE” (French) “UEG” (German)
O2	Oxygen (O ₂)
NO2	Nitrogen Dioxide (NO ₂)
H2S	Hydrogen Sulfide (H ₂ S)
CO _L	CO H ₂ /Low

Alpha-numeric display values	Definition
%VOL	Percentage Volume: O ₂ and CH ₄ measurement unit
% LEL	Percentage unit for combustible gases; display variations: “% LEL” (English) “% LIE” (French) “% UEG” (German)
PPM	Parts Per Million: H ₂ S, CO, SO ₂ and NO ₂ measurement unit.
	Over-range: for any sensor in over-range, indicates the measured gas concentration is greater than the measurement range of the sensor. Display variations: “Or” (English and German) “Sup” (French)
- 	Negative Over-range: for any sensor in negative over-range indicates the measured gas concentration is less than the negative measurement range of the sensor. Display variations: “-Or” (English and German) “InF” (French)
Bottom Row Icons	Definition
	Battery level indicator; display variations: Empty battery icon with three dashes in place of each sensor reading = critical battery warning Flashing empty battery icon = low battery warning 1 black bar = < 33% charge remaining 2 black bars = 34% – 66% charge remaining 3 black bars = 67% – 100% charge remaining
	Security Code: indicates code is set or to be entered.
	Pump: shown anytime an aspirated monitor is in use.
	Indicates IrDA communication is in-progress.
STEL	Short Term Exposure Limit: communicates STEL values. Display variations: “STEL” (English and German) “VLE” (French)
TWA	Time Weighted Average: communicates TWA values. Display variations: “TWA” (English and German) “VME” (French)





Alarms

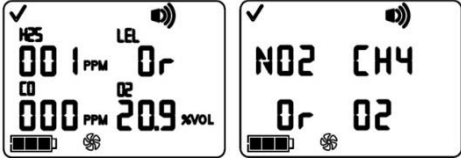

IMPORTANT

- Take all monitor alarms and warnings seriously and respond to them as stated in company safety policy.
- Once initiated, an alarm will remain on while the alarm condition is present. For gas-related alarms, once the detected gas concentration changes, the alarm indicators will change to reflect any new condition such as low-alarm gas, high-alarm gas, over-range gas, or no gas alarm.
- When the latch alarm feature is enabled and the monitor goes into alarm, it will remain in alarm until the alarm condition no longer exists *and* the monitor user presses the ENTER button for one second. This applies only to gas-related alarms.

It is practical for the monitor user to be aware of the possible alarms prior to monitor set-up and use. The Ventis MX4 has four alarm and warning levels. A “system level” alarm generates the highest frequency tone and highest level visual and vibration signals. It is used to indicate such events as a pump, critical battery failure, or sensor failure. The “high” or “low” level audio alarms, in combination with visual and vibration indicators, turn on when gas concentration readings are over-range, high, or low. The lowest level indicator is a warning with beep patterns to indicate service needs (e.g., low battery or calibration due). The beep is also used as a confidence indicator when enabled.

Alarm types and their alarm generating conditions are described below.

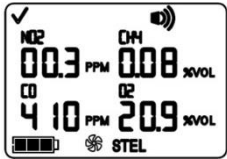
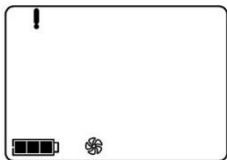
Display	Description
 <p>Over-range Alarm Screen The “Or” message indicates which sensor(s) is reading an over-range condition(s). All other sensors show their current gas concentration readings on a numeric display (left) or gas names on a text display (right). The high level alarms turn on and the alarm icon displays.</p>	<p>An over-range condition occurs when the gas concentration value sensed is above the sensor’s measuring range.</p> <p>After any over-range alarm, the monitor should be calibrated.</p> <p><i>Note:</i> The O₂ and toxic sensor values normally reset when the gas sensed reaches an acceptable range.</p> <p>If the LEL reads over-range, the alarm latches and the LEL sensor is automatically turned off. Press the enter button to turn on the LEL sensor. This will turn off the alarm indicators. After a warm-up period of approximately 30 seconds, an LEL reading will display. If the new reading is an over-range or other alarm condition, the alarm indicators will turn on.</p>
 <p>Negative Over-range Alarm Screen The “-Or” message indicates which sensor is reading a negative over-range condition. All other sensors display their current gas concentration readings*. The high level alarms turn on and the alarm icon displays.</p>	<p>A negative over-range condition occurs when the gas concentration value sensed is less than the sensor’s measuring range.</p> <p>After any negative over-range alarm, the monitor should be calibrated.</p>
 <p>High Alarm Screen A flashing gas concentration value* indicates which sensor(s) reading(s) is the cause for alarm. The high level alarms turn on and the up arrow icon displays.</p>	<p>A high alarm condition occurs when the concentration of gas sensed reaches a level greater than the monitor’s high alarm value setting for a sensor(s).</p>
 <p>Low Alarm Screen A flashing gas concentration value* indicates which sensor(s) reading(s) is the cause for alarm. The low level alarms turn on and the down arrow icon displays.</p>	<p>A low alarm condition occurs when the concentration of gas sensed reaches the monitor’s low alarm value setting for a sensor(s).</p>

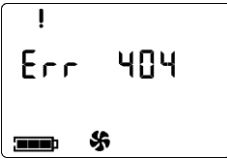
Display	Description
 <p>TWA Alarm Screen A flashing gas concentration value* indicates which sensor(s) reading(s) is the cause for alarm. The low level alarms turn on and the TWA icon flashes.</p>	<p>A TWA alarm occurs when the calculated time weighted average reaches the monitor's hazardous value for the set time frame.</p>
 <p>STEL Alarm Screen A flashing gas concentration value* indicates which sensor(s) reading(s) is the cause for alarm. The high level alarms turn on and the STEL icon flashes.</p>	<p>The STEL alarm occurs when the short term exposure value exceeds the acceptable limit.</p>
 <p>No Sensor Installed Screen The system level alarms turn on and the error icon displays.</p>	<p>Alarm occurs when the monitor registers no sensors installed.</p>
 <p>Sensor Data Fail Screen A flashing "F" indicates which sensor is the cause for alarm. The audio alarm turns on and the error icon displays.</p>	<p>Alarm occurs when any installed sensor's data-related operations fail and the sensor is not operational.</p>
 <p>Critical Error Screen</p>	<p>Error codes 4XX to 5XX (404 shown here) indicate the monitor has detected a malfunction. The unit is not operational and should be examined by a qualified technician or reported to Industrial Scientific for service or repair information.</p>

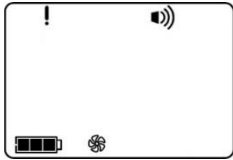
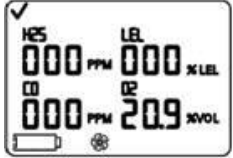
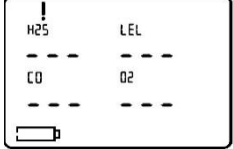
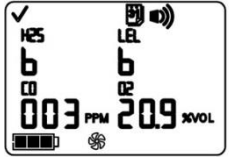
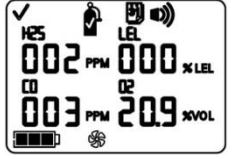
Display	Description
 <p>Pump Fault Alarm The system level alarms turn on and the error icon displays.</p>	<p>Alarm occurs when an attached pump is not operating correctly. While in alarm, every ten seconds the monitor attempts to restart the pump. If unsuccessful, the monitor remains in alarm.</p> <p><i>Note:</i> The nominal flow rate is >200 cc/m (0.2 LPM). A pump fault alarm will occur when the flow is less than 200 cc/m +0, -25%.</p>
 <p>Low Battery Warning Screen A beep sounds every 60 seconds and the empty battery icon flashes.</p>	<p>Alarm occurs when the monitor's battery reaches a low level of charge or is nearing its end of life.</p>
 <p>Critical Battery Alarm The empty battery icon indicates a battery life warning, while three dashes display in place of each sensor reading. The high alarm sounds for 10 minutes before powering off the monitor.</p>	<p>This alarm occurs when there is not enough battery life remaining for continued operation. The battery must be charged or replaced. <i>The instrument is NOT detecting gas at this time.</i></p>
 <p>Bump Overdue Screen A "b" indicates which sensor(s) is overdue for bump testing. Two beeps sound every 30 seconds and the calendar and alarm icons display.</p>	<p>Alarm occurs when one or more sensors are due for a bump test. If the monitor settings permit, an in-field bump test may be performed in an area known to be nonhazardous.</p>
 <p>Calibration Due Alarm Screen The gas value flashes for each sensor overdue for calibration. Three beeps sound every 30 seconds and the calendar and alarm icons display. The gas cylinder icon flashes.</p>	<p>Alarm occurs when one or more sensors are due for calibration. If the monitor settings permit, an in-field calibration can be performed in an area known to be nonhazardous.</p>
<p>*The numeric mode display shows gas concentration values; the text mode display shows gas type names in place of gas values.</p>	





► Monitor Set-up

Preparing the monitor for first time use is a “3-C” process: *charge* (if equipped with a lithium-ion battery), *configure*, and *calibrate*. This manual section covers charging and configuration for set-up purposes and can be consulted for ongoing instruction thereafter. Calibration is covered in the section, [Zero, Calibration, and Bump testing](#).

Batteries

As shown below, the Lithium-ion and Slim extended lithium-ion batteries are compatible with the diffusion instrument only. The Extended range battery can be installed for use with a diffusion or aspirated instrument. The battery's orderable part numbers are supplied in [Battery part numbers and options](#).

Battery Compatibility

	Lithium-ion battery (VTSB-1XY*) 	Rechargeable (part number*) Slim extended lithium-ion battery (VTSB-4XY*) 	Extended range lithium-ion battery (VTSB-2XY*) 	Replaceable (part number*) Alkaline battery (VTSB-3XY*) 
Ventis MX4 diffusion	Yes	Yes	Yes	Yes
Ventis MX4 aspirated	No	No	Yes (without cover)	Yes (without cover)

*X indicates color and Y indicates approvals.

Docking Stations, Chargers, and other Accessories

Fully charge the monitor before first use. The lithium-ion equipped Ventis MX4 can be charged using any of the products listed below.

Part Number	Product
Docking Stations	
18109327	DSX™ Docking Station for Ventis
Calibration Stations	
18108631	V-Cal™ Calibration Station
18107664	V-Cal™ 6-Unit Calibration Station
Chargers	
18108191	Ventis Single Unit Charger
18108209	Ventis Single Unit Charger / Datalink
18108650	Ventis 6-Unit Charger
18108651	Ventis Single Unit Automotive Charger, 12 VDC
18108652	Ventis Single Unit Truck-Mount Charger, 12 VDC, with Cigarette Adapter
18108653	Ventis Single Unit Truck-Mount Charger, 12 VDC, Hard Wired

Note: The above products are all equipped with an LED indicator. This indicator displays as solid green when no instrument is in the charger or when a fully charged instrument is placed in the charger, solid amber when an instrument is charging, and toggles between green and amber when “topping off” charging—adding additional charge to a partially charged instrument. Check the monitor's battery level indicator to confirm the battery charge level.

Battery Charging

Charger insert placement

If the charger includes an insert, adjust the insert's position to ensure the battery contacts touch the charging contacts.

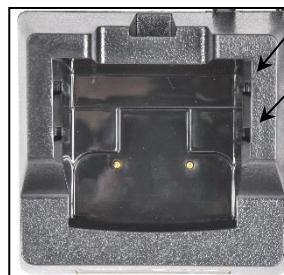

● Rear insert position
● Forward insert position



Lithium-ion battery

Insert side 1: forward position



Slim extended lithium-ion battery

Insert side 2: forward position



Extended range lithium-ion battery

Insert side 1: Rear position

Once the insert is placed into the desired position, a firm push down will secure it in place.





To prevent losing the insert, keep it in the cradle in the most often used position.

Note: Do NOT touch the battery contacts located at the front of the charger as contaminants and damage will inhibit the battery's ability to charge.

Power-on and -off

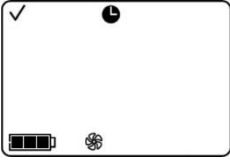
To power-on the Ventis MX4, press the *ON/OFF/MODE* button and hold for three to five seconds. During the first ten to 15 seconds the monitor is on, its firmware completes internal tests and the user sees or hears what is described and shown below. Following this initialization phase, a countdown screen displays. During this 20-second countdown, the monitor user can enter configuration mode to manually adjust monitor settings.

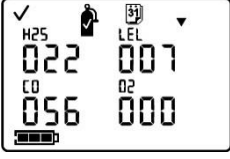
Display and Options	Instructions
 <p>Visual Test Screen Displays for up to five seconds as the monitor completes a sensor and alarm check. Visual, vibration, and audio alarms turn on briefly, then off.</p>	<p>No user action required.</p>

Display and Options	Instructions
 <p>Pump Set-up Screen Displays for five to seven seconds for an aspirated monitor. The monitor checks for the presence of a pump. If present, the pump is started and, if needed, adjusted for optimum flow.</p>	<p>Be sure the pump inlet is <i>not</i> blocked.</p>
 <p>Software Version Screen The Software Version Screen message displays for five seconds.</p>	<p>No user action required.</p>
 <p>Calibration Days Screen When the up arrow (▲) is featured, the number of days displayed for each sensor indicates when the <i>next</i> calibration is due. When the down arrow (▼) is featured, the number of days displayed indicates when the <i>last</i> calibration occurred.</p>	<p>No user action required.</p>
 <p>Countdown Screen Displays the 20 second countdown, one second at a time, from 20 to one. Options : Enter gas monitoring mode Enter configuration mode</p>	<p>To enter <i>gas monitoring</i> mode: Allow the countdown to complete and advance to the Gas Monitoring Screen.</p> <p>To enter <i>configuration</i> mode: Simultaneously press <i>ON/OFF/MODE</i> and <i>ENTER</i>, hold for three seconds, and release.</p>
 <p>Power-Off Screen The screen displays a five-second countdown accompanied by five beeps and LED flashes.</p>	<p>Press <i>ON/OFF/MODE</i>, hold for the full five second countdown to zero, and release to power-off the monitor.</p>

Configuration

Introduction

Before first time use of the monitor, its settings should be reviewed and, if needed, be adjusted. Qualified safety personnel should complete the following tasks.

- Review the monitor settings for compliance with company policy and any applicable regulations, laws, and observed guidelines as issued by regulatory agencies and government or industry groups.
- Determine which settings, if any, require adjustment.
- Make the adjustments or supervise other qualified personnel in the process.
- When using instrument-compatible Industrial Scientific docking station software (e.g., iNet, Docking Station Server Administrative Console [DSSAC], or Accessory Software), maintain the mandated settings through the software or by manually configuring the instrument settings after docking.

Monitor settings should be reviewed regularly and adjusted as needed. The following settings are adjustable or “configurable” for the Ventis MX4.

LEL Type
 Calibration Mode Setting
 Low Alarm Settings
 High Alarm Settings
 TWA Alarm Settings
 TWA Interval Settings
 STEL Alarm Setting
 Calibration Gas Settings
 Clock Settings
 Date Settings
 Display Mode Setting
 Confidence Indicator (on/off)
 Confidence Indicator (type)
 Bump Test In-field
 Bump Test Due Warning
 Bump Test Time Set-point
 Bump Test Percentage
 Bump Test Response Time
 Alarm Latch Set
 Zero In-field
 Calibration In-field
 Calibration Due Alarm
 Calibration Due Set-point
 Security Code
 Language Selection
 Always-on Setting
 Shutdown In Alarm Setting
 Alarm on Dock Setting

The Ventis MX4 can be configured manually as instructed below. Any changes made take effect immediately upon exiting the configuration mode.

Instructions

IMPORTANT

- The configuration mode should be accessed only by safety personnel authorized to change monitor settings based on company policy.
- Read ALL requirements and instructions outlined below, including the screen-by-screen process description, before beginning the configuration process.

The configuration mode can be entered during the 20-second countdown of the power-on process. During the countdown, *simultaneously* press *ON/OFF/MODE* and *ENTER*, hold for three seconds, and release to enter configuration mode. (While in the configuration mode, the same button presses cause the monitor to exit configuration). Each configuration screen times out after 30 seconds and the monitor enters gas monitoring mode. To re-enter the configuration mode, power-off the monitor, then power-on and repeat the entry process.

Throughout the configuration process, the main functions of the two buttons are as follows.

- The ENTER button is used to *edit* values. It is also used, where noted, to begin a process or a step in a process.
- The ON/OFF/MODE button is used to *set* the value. Where noted, it is also used to bypass a process or step in a process, or to advance to the next configuration screen.



The first screen to display in configuration mode depends on three things:



- security code setting,
- the presence or absence of the China MA feature,
- and the presence or absence of an LEL sensor.



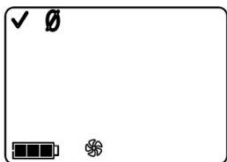

If the security code setting is 000, the security feature is *disabled* and the Enter Security Code Screen does NOT appear. If the security code is NOT 000, the security feature is *enabled* and the monitor displays the Enter Security Code Screen.

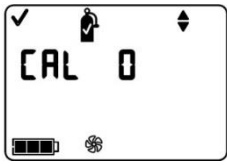

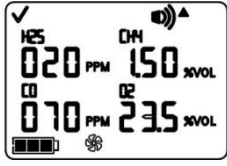
The monitor next checks for the presence of a China MA mining feature. If this feature is operational, the monitor displays the Zero Initiate Screen.

If the China MA mining feature is NOT operational, the monitor then checks for an installed LEL sensor. If installed, the monitor displays the LEL Type Screen. If no LEL sensor is installed, the monitor displays the Zero Initiate Screen.

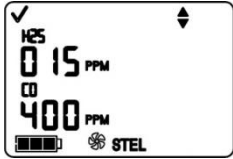

Configuration Process	
Display and Options	Instructions
 <p>Enter Security Code Screen The presence of this screen indicates an enabled security feature.</p>	<p>Press <i>ENTER</i> to edit the value, if needed; press repeatedly or hold down to speed the increment pace to reach the valid security code. Press <i>ON/OFF/MODE</i> to enter configuration mode and arrive at the next applicable screen.</p>
 <p>LEL Type Set Screen Options: LEL or CH₄</p>	<p>Press <i>ENTER</i> to edit the value, if needed. Press <i>ON/OFF/MODE</i> to set the value and advance to the Zero Initiate Screen.</p> <p><i>Note:</i> If the LEL type is changed, the sensor goes into calibration fail mode. A full calibration is required before the monitor can be used and is accessible from the next screen in the configuration process, the Zero Initiate Screen. For complete calibration instructions, see the manual section, Zero, Calibration, and Bump testing.</p>
 <p>Zero Initiate Screen Options Bypass zero and calibration process. Begin zero and calibration process.</p>	<p>Press <i>ON/OFF/MODE</i> to bypass the zero and calibration processes and advance to one of two screens.</p> <p>If the installed sensor set includes H₂S and NO₂, OR, SO₂ and NO₂, the monitor is pre-set for standard calibration mode and the Low Alarm Set-point Screen displays.</p> <p>For all others installed sensor combinations, the Calibration Mode Selection Screen displays.</p> <p>Press <i>ENTER</i> to begin the zero and calibration process. Proceed to the manual section, Zero, Calibration, and Bump testing.</p>

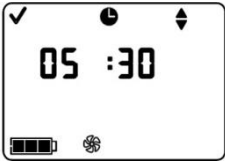
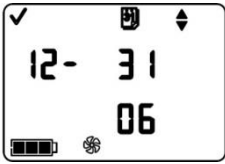
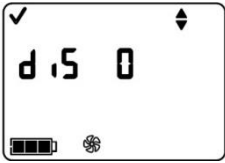

Configuration Process	
Display and Options	Instructions
 <p>Calibration Mode Selection Options 0 = Standard Calibration 1 = Quick Calibration</p>	<p>The quick calibration option sets the monitor to calibrate all four sensors simultaneously. The standard calibration option sets the monitor to calibrate each sensor independently.</p> <p>Press <i>ENTER</i> to edit the value, if needed. Press <i>ON/OFF/MODE</i> to set the value and advance to the Low Alarm Set Screen.</p>
<p><i>Note:</i> The user can edit the values for four alarm types in configuration mode. The monitor presents these options in the order shown below.</p> <ol style="list-style-type: none"> 1. Low alarm 2. High alarm 3. TWA (if toxic sensors installed) 4. STEL (if toxic sensors installed) <p>For each alarm type (e.g., low alarm), the user can edit the alarm settings for each installed sensor, one sensor at a time. The order in which the sensors are subject to change is as follows.</p> <ol style="list-style-type: none"> 1. Toxic sensor 1 2. LEL sensor 3. Toxic sensor 2 4. O₂ sensor 	
 <p>Low Alarm Set-point Screen Displays the existing low alarm value for each installed sensor. If any one of the sensors is NOT installed, its position on the display is blank.</p>	<p>Press <i>ON/OFF/MODE</i> to bypass the low alarm value set process and advance to the High Alarm Set-point Screen. Press <i>ENTER</i> to begin the low alarm value set process. On the display, the first sensor subject to change flashes. Press <i>ENTER</i> to edit the value, if needed; press repeatedly or hold down to speed the increment pace. Press <i>ON/OFF/MODE</i> to set the value.</p> <p>The next sensor subject to change flashes. Continue to use the <i>ENTER</i> and <i>ON/OFF/MODE</i> buttons, respectively, to edit and set each sensor's low alarm value.</p> <p>After the alarm value is set for each installed sensor, press <i>ON/OFF/MODE</i> to advance to the High Alarm Set-point Screen.</p>
 <p>High Alarm Set-point Screen Displays the existing high alarm value for each installed sensor. If any one of the sensors is not installed, its position on the display is blank.</p>	<p>Press <i>ON/OFF/MODE</i> to bypass high alarm value set process and advance to one of two screens as noted below. Press <i>ENTER</i> to begin the high alarm value set process. On the display, the first sensor subject to change flashes. Press <i>ENTER</i> to edit the value, if needed; press repeatedly or hold down to speed the increment pace. Press <i>ON/OFF/MODE</i> to set the value.</p> <p>The next sensor subject to change flashes. Continue to use the <i>ENTER</i> and <i>ON/OFF/MODE</i> buttons, respectively, to edit and set each sensor's high alarm value.</p> <p>After the alarm value is set for each installed sensor, press <i>ON/OFF/MODE</i> and advance to one of two screens.</p>

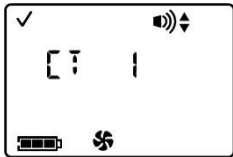
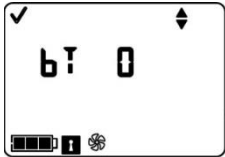
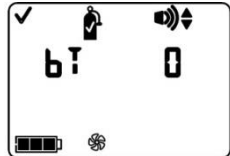
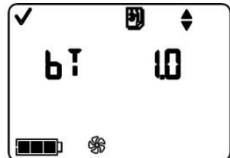

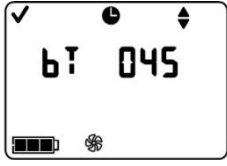
Configuration Process	
Display and Options	Instructions
	<p>If at least one toxic sensor is installed, the TWA Alarm Set Screen displays. If NO toxic sensors are installed, the Calibration Gas Set Screen displays.</p>
 <p>TWA Alarm Set-point Screen Displays the existing TWA values for the toxic sensors installed. No other sensor readings appear.</p>	<p>Press <i>ON/OFF/MODE</i> to bypass the TWA alarm value set process and advance to the TWA Interval Set-point Screen. Press <i>ENTER</i> to begin the TWA alarm value set process. On the display, the first sensor subject to change flashes. Press <i>ENTER</i> to edit the value, if needed; press repeatedly or hold down to speed the increment pace. Press <i>ON/OFF/MODE</i> to set the value.</p> <p>The next sensor subject to change flashes. Continue to use the <i>ENTER</i> and <i>ON/OFF/MODE</i> buttons, respectively, to edit and set each alarm value.</p> <p>After the alarm value is set for each installed sensor, press <i>ON/OFF/MODE</i> to advance to the TWA Interval Set Screen.</p>
 <p>TWA Interval Set-point Screen Displays the existing TWA interval. The value can be set from one to 40 hours, in increments of one.</p>	<p>Press <i>ENTER</i> to edit the value, if needed. Press <i>ON/OFF/MODE</i> to set the value and advance to the STEL Alarm Set-point Screen.</p>
 <p>STEL Alarm Set-point Screen Displays the existing STEL values for the toxic sensors installed. No other sensor readings appear.</p>	<p>Press <i>ON/OFF/MODE</i> to bypass the STEL alarm value set process and advance to the Calibration Gas Set Screen. Press <i>ENTER</i> to begin the STEL alarm value set process. On the display, the first sensor subject to change flashes. Press <i>ENTER</i> to edit the value, if needed; press repeatedly or hold down to speed the increment pace. Press <i>ON/OFF/MODE</i> to set the value.</p> <p>The next sensor subject to change flashes. Continue to use the <i>ENTER</i> and <i>ON/OFF/MODE</i> buttons, respectively, to edit and set each sensor's STEL alarm value.</p> <p>After the alarm value is set for each installed sensor, press <i>ON/OFF/MODE</i> to advance to the Calibration Gas Set Screen.</p>
 <p>Calibration Gas Set Screen Displays the existing calibration gas value for each installed sensor.</p>	<p>Press <i>ON/OFF/MODE</i> to bypass the calibration gas set process and advance to the Clock Set Screen. Press <i>ENTER</i> to begin the calibration gas value set process. On the display, the first sensor subject to change flashes. Press <i>ENTER</i> to edit the value, if needed; press repeatedly or hold down to speed the increment pace. Press <i>ON/OFF/MODE</i> to set the value.</p> <p>The next sensor subject to change flashes. Continue to use the <i>ENTER</i> and <i>ON/OFF/MODE</i> buttons, respectively, to edit and set each sensor's calibration gas value.</p>

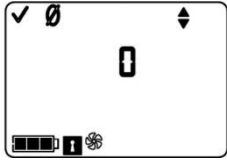
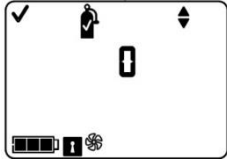
Configuration Process	
Display and Options	Instructions
<p>If any one of the sensors is not installed, its position on the display is blank.</p>	<p>After calibration gas value is set for each installed sensor, press <i>ON/OFF/MODE</i> to advance to the Clock Set Screen.</p>
 <p>Clock Set Screen Displays the existing time values using a 24-hour time format.</p>	<p>Press <i>ON/OFF/MODE</i> to bypass the clock set process and advance to the Date Set Screen. Press <i>ENTER</i> to begin the clock set process. On the display, the first time value subject to change flashes. Press <i>ENTER</i> to edit the value, if needed; press repeatedly or hold down to speed the increment pace. Press <i>ON/OFF/MODE</i> to set the value. The next value subject to change flashes. Use the <i>ENTER</i> and <i>ON/OFF/MODE</i> buttons, respectively, to edit the value. After all values are set, press <i>ON/OFF/MODE</i> and advance to the Date Set Screen.</p>
 <p>Date Set Screen Displays the existing date. The value displayed on the far left is the month and to its right the day. The year is displayed beneath the day.</p>	<p>Press <i>ON/OFF/MODE</i> to bypass the date set process and advance to the Display Mode Set Screen. Press <i>ENTER</i> to begin the date set process On the display, the first date value subject to change flashes. Press <i>ENTER</i> to edit the value, if needed; press repeatedly or hold down to speed the increment pace. Press <i>ON/OFF/MODE</i> to set the value. The next date value subject to change flashes. Continue to use the <i>ENTER</i> and <i>ON/OFF/MODE</i> buttons, respectively, to edit and set each value. After all values are set, press <i>ON/OFF/MODE</i> and advance to the Display Mode Set Screen.</p>
 <p>Display Mode Set Screen Options 0 = Numeric Mode 1 = Text Mode</p>	<p>The display mode selected determines whether the monitor user will see a numeric or text display (including alarm displays) when the monitor is in the gas monitoring mode. Press <i>ENTER</i> to edit the value, if needed. Press <i>ON/OFF/MODE</i> to set the value and advance to the Confidence Indicator Set Screen.</p>
 <p>Confidence Indicator On-Off Screen Options 0 = Disable/off 1 = Enable/on</p>	<p>With an enabled confidence indicator, the monitor will emit a signal, every 90 seconds in gas monitoring mode, to inform the user it is operational. Press <i>ENTER</i> to edit the value, if needed. Press <i>ON/OFF/MODE</i> to set the value and advance to one of two screens.</p> <ul style="list-style-type: none"> • If the confidence indicator is enabled, the Confidence Indicator Type Set Screen displays. • If the confidence indicator is disabled, the Bump Test In-field Option Screen displays.

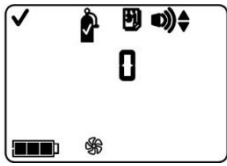
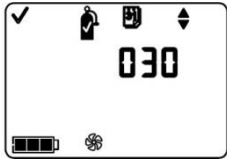
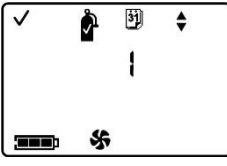
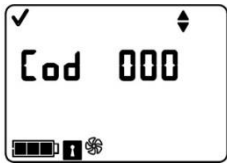
Configuration Process	
Display and Options	Instructions
 <p>Confidence Indicator Type Set Screen Options 1 = audible chirp 2 = LED flash 3 = audible chirp and LED flash</p>	<p>Sets the type of signal that will be emitted by an enabled confidence indicator.</p> <p>Press <i>ENTER</i> to edit the value, if needed. Press <i>ON/OFF/MODE</i> to set the value and advance to the Bump Test In-field Option Screen.</p>
 <p>Bump Test In-field Option Screen Options 0 = Disable/off 1 = Enable/on</p>	<p>When enabled, permits all monitor users to bump test the monitor from the gas monitoring mode.</p> <p>Press <i>ENTER</i> to edit the value, if needed. Press <i>ON/OFF/MODE</i> to set the value and advance to one of two screens.</p> <ul style="list-style-type: none"> • If Bump Test In-field is enabled, the Bump Due Warning Option Screen displays. • If the Bump Test In-field is disabled, the Alarm Latch Set Screen displays.
 <p>Bump Due Warning Option Screen Options 0 = Disable/off 1 = Enable/on</p>	<p>When enabled, the monitor will sound two beeps every 30 seconds and its display icons will indicate a bump test is due.</p> <p>Press <i>ENTER</i> to edit the value, if needed. Press <i>ON/OFF/MODE</i> to set the value and advance to the Bump Test Time Set-point Screen.</p>
 <p>Bump Test Time Set-point Screen Value range: 0.5 days to 7.0 days Value increment: 0.5 days</p>	<p>Sets the elapsed time allowed between bump tests.</p> <p>Press <i>ENTER</i> to edit the value, if needed; press repeatedly or hold down to speed the increment pace. Press <i>ON/OFF/MODE</i> to set the value and advance to the Bump Test Percentage Requirement Screen.</p>

Configuration Process	
Display and Options	Instructions
 <p>Bump Test Percentage Requirement Screen Value range: 50% to 99% Value increment: one percent</p>	<p>Sets the percentage of calibration gas the monitor expects to be exposed to.</p> <p>Press <i>ENTER</i> to edit the value, if needed; press repeatedly or hold down to speed the increment pace.</p> <p>Press <i>ON/OFF/MODE</i> to set the value and advance to the Bump Test Response Time Screen.</p>
 <p>Bump Test Response Time Screen Value range: 30 to 300 seconds Value increment: five seconds</p>	<p>Sets the bump test response time period.</p> <p>Press <i>ENTER</i> to edit the value, if needed; press repeatedly or hold down to speed the increment pace.</p> <p>Press <i>ON/OFF/MODE</i> to set the value and advance to the Latch Alarm Set Screen.</p>
 <p>Latch Alarm Set Screen Options 0 = Normal mode 1 = Latching mode</p>	<p>When enabled, if the monitor goes into any gas-related alarm, it will remain in alarm until after the gas concentration is less than (or more than for oxygen) the alarm set point, and the monitor user presses the <i>ENTER</i> button for one second.</p> <p>Press <i>ENTER</i> to edit the value, if needed.</p> <p>Press <i>ON/OFF/MODE</i> to set the value and advance to the Zero In-field Screen.</p>
 <p>Zero In-field Screen Options 0 = Disable/off 1 = Enable/on</p>	<p>When enabled, all monitor users are permitted to zero the monitor from the gas monitoring mode.</p> <p>Press <i>ENTER</i> to edit the value, if needed.</p> <p>Press <i>ON/OFF/MODE</i> to set the value and advance to one of two screens.</p> <p>If Zero In-field is enabled, the Calibration In-field Option screen displays.</p> <p>If Zero In-field is disabled, the Calibration Due Alarm screen displays.</p>
 <p>Calibration In-field Option Screen Options 0 = Disable/off 1 = Enable/on</p>	<p>When enabled, all monitor users are permitted to calibrate the monitor from the gas monitoring mode.</p> <p>Press <i>ENTER</i> to edit the value, if needed.</p> <p>Press <i>ON/OFF/MODE</i> to set the value and advance to the Calibration Due Alarm Option.</p>

Configuration Process	
Display and Options	Instructions
 <p>Calibration Due Alarm Option Screen Options 0 = Disable/off 1 = Enable/on</p>	<p>When enabled, the monitor will activate the calibration due alarm, in gas monitoring mode, when any sensor is due for calibration. A flashing gas cylinder and gas type will appear on the display and three beeps will sound every 30 seconds.</p> <p>Press <i>ENTER</i> to edit the value, if needed. Press <i>ON/OFF/MODE</i> to set the value and advance to the Calibration Due Set-point screen.</p>
 <p>Calibration Due Set-point Screen Value range: one to 365 days Value increment: one day</p>	<p>Sets the elapsed time allowed between calibrations.</p> <p>Press <i>ENTER</i> to edit the value, if needed. Press <i>ON/OFF/MODE</i> to set the value and advance to the Calibration Days Set Screen.</p>
 <p>Calibration Days Set Screen Options 0 = display days since <i>last</i> calibration 1 = display days until <i>next</i> calibration</p>	<p>Sets how the Calibration Days Screen will display in operation mode.</p> <p><i>Note:</i> The up arrow (▲) will be featured on-screen when the unit is set to display the number of days before a sensor's <i>next</i> calibration is due. The down arrow (▼) will be featured when the unit is set to display the number of days since the <i>last</i> calibration was performed. A value will be displayed for each installed sensor.</p> <p>Press <i>ENTER</i> to edit the value, if needed. Press <i>ON/OFF/MODE</i> to set the value and advance to the Security Code Set Screen</p>
 <p>Security Code Set Screen Valid values: 000 to 999. Increment value: one</p>	<p>A security code value of 000 permits all monitor users to enter configuration mode and gain access to change the monitor's settings. A value other than 000 will restrict access to the configuration mode; it will also restrict access to the shutdown process for an instrument that is configured for "always on".</p> <p>Press <i>ENTER</i> to edit the value, if needed; press repeatedly or hold down to speed the increment pace. Press <i>ON/OFF/MODE</i> to set the value and advance to the Language Selection Screen.</p>
 <p>Language Selection Screen Options E = English F = French d = German</p>	<p>Allows the choice of display languages as applied to select screens.</p> <p>Press <i>ENTER</i> to edit the value, if needed. Press <i>ON/OFF/MODE</i> to set the value and return to the LEL Type Set Screen.</p>

Configuration Process	
Display and Options	Instructions
 <p>Always-on Set Screen Options 0 = Disable/off 1 = Enable/on</p>	<p>When enabled, the shutdown process is security-code protected only if the security code is not equal to 000. If the code is set to anything other than 000, the user will be prompted to enter the unit's security code to complete the shutdown process.</p> <p>Press <i>ENTER</i> to edit the value, if needed. Press <i>ON/OFF/MODE</i> to set the value and advance to the next configuration mode screen.</p>
 <p>Shutdown In Alarm Screen Options 0 = Disallows shutdown 1 = Allows shutdown</p>	<p>Disallow or allow operator-activated shutdown when the unit is in alarm.</p> <p>Press <i>ENTER</i> to edit the value, if needed. Press <i>ON/OFF/MODE</i> to set the value and advance to the next configuration mode screen.</p>
 <p>Alarm on Dock Screen Options 0 = Disable/off 1 = Enable/on</p>	<p>Disable or enable alarm indicators when the unit is docked.</p> <p>Press <i>ENTER</i> to edit the value, if needed. Press <i>ON/OFF/MODE</i> to set the value and advance to the next configuration mode screen.</p>

► Monitor Use and Service

Proper monitor use and service includes everything from bump testing and calibration to keeping the monitor clean, proper air sampling, and the replacement of parts and components. Beginning with calibration and bump testing, the following sections provide information and instruction on all use and service tasks.

Zero, Calibration, and Bump testing

Gas detection instruments are potentially life-saving devices. When completed regularly, the procedures defined below help to maintain proper instrument functionality and enhance operator safety.

Procedures

Configuration. The configuration process allows qualified personnel to review and adjust a unit's settings.

Bump Test (or "functional test"). Bump testing checks for sensor and alarm functionality. The installed sensors are briefly exposed to expected concentrations of calibration gases that are greater than the sensors' low alarm set points. When one or more sensors "pass" the test, they are "functional" and the unit will alarm. Each sensor's "pass" or "fail" result is indicated on the unit's display.

Note: a bump test does not measure for sensor *accuracy* (see "Calibration").

Zero. Zeroing sets each installed sensor to recognize the ambient air as clean air. If the ambient air is not truly clean air, any gases that are present and relevant to the installed sensor types will be measured and displayed as zero. Readings will be inaccurate until the unit is correctly zeroed in truly fresh air or with a zero air cylinder.

Calibration. All sensors gradually degrade over time. This diminishes a sensor's ability to measure gas concentrations accurately; however, regular calibrations adjust the instrument to compensate for this decline in sensitivity. During calibration, the installed sensors are exposed to expected concentrations of calibration gases and, when needed, the instrument will self-adjust to ensure the accurate measurement and display of gas concentration values.

Note: When a sensor has degraded beyond an acceptable level, no further adjustment is possible, and the sensor will no longer pass calibration.

Peak Readings. The instrument stores the highest detected gas readings, the "peak readings" or "peaks". Bump testing and calibration will often register new peak readings. Therefore, the clearing of the peak readings should *follow* each calibration. The instrument operator may also wish to clear the peak readings after a bump test, before a change in location, or after an alarm is addressed and cleared.

Note: The peak readings and the data log readings are stored independently of one another; therefore, clearing the peak reading does not affect the data log. Powering the instrument off or changing its battery does not affect the peak reading. These checks and balances help promote operator safety and serve to contain the peak readings in a "black-box" manner. In the event of a gas-related incident, this black-box record can be useful to the safety team or a prospective investigator.

Recommendations

Industrial Scientific Corporation minimum frequency recommendations for each procedure are summarized in the table below. These recommendations are based on field data, safe work procedures, industry best practices, and regulatory standards to help ensure worker safety. Industrial Scientific is not responsible for setting safety practices and policies. These policies may be affected by the directives and recommendations of regulatory groups, environmental conditions, operating conditions, instrument use patterns and exposure to gas, and other factors.

Procedure	Industrial Scientific Recommended minimum frequency
Configuration	Before first use and as needed thereafter.
Calibration ^a	Before first use and monthly thereafter.
Bump test ^b	Prior to each day's use.

^aBetween regular calibration procedures, Industrial Scientific also recommends that calibration be performed immediately following each of these incidences: the unit falls, is dropped, or experiences another significant impact; is exposed to water; fails a bump test; or has been repeatedly exposed to an over-range (positive or negative) gas concentration. Calibration is also recommended after the installation of a new (or replacement) sensor.

^bIf conditions do not permit daily testing, bump tests may be done less frequently based on company safety policy.

Note: The use of calibration gases not provided by Industrial Scientific may void product warranties and limit potential liability claims.

General information

The zero, calibration, and bump testing tasks can be in-field *enabled* or in-field *disabled* in the configuration process. This setting permits or denies access to these functions from the gas monitoring mode. When any of these options is enabled, it is accessible to *all* monitor users. In gas monitoring mode, a series of presses on the *ON/OFF/MODE* button gives the user access to the following screens and processes in the order shown.

- Gas Monitoring Screen
- Days Since Calibration
- Zero Initiate (if in-field enabled)
- Calibration Apply Gas Screen (if in-field enabled)
- Bump Test Initiate (if in-field enabled)
- Peak Readings
- TWA Readings
- STEL Readings

The monitor is capable of performing two types of calibration, and this option is set in configuration mode. The calibration type selected also determines the monitor's bump test type. With a "quick" calibration, the monitor is set to calibrate and bump test all installed sensors simultaneously. With a "standard" calibration setting, these tasks are completed independently for each installed sensor in the order shown below.

1. Oxygen sensor*
2. Toxic sensor 1
3. LEL sensor
4. Toxic sensor 2

*Note: If set to the default value of 20.9% or 21%, the Oxygen sensor calibrates during the zero process and toxic sensor 1 is the first sensor to calibrate during calibration.

The Ventis MX4 monitor can be calibrated with any of the accessories listed.

- Calibration cup and/or tubing shipped with the monitor (see instructions below).
- V-Cal Calibration Station (consult the calibration station manual for instruction).
- DSX™ Docking Station for Ventis MX4 (consult the docking station manual for instruction).

Instructions

Calibration and Bump Testing with Calibration Cup and/or Tubing

Read all instructions before beginning: notices, supply check-list, gas cylinder preparation, and the complete screen-by-screen walk-through of the zero, calibrate, and bump test processes. Each process is presented in the order in which it is accessible from gas monitoring mode.

IMPORTANT

- Industrial Scientific recommends that full monitor calibration be performed, using a known certified concentration(s) of Industrial Scientific calibration gas(es), to prepare the monitor for first time use, and monthly (at a minimum) thereafter, to help ensure monitor accuracy.
- Industrial Scientific also recommends that each monitor be zeroed and bump tested before each use with a known certified concentration(s) of Industrial Scientific calibration gas(es).
- Read ALL requirements and instructions outlined below, including the screen-by-screen process description, before beginning the zero, calibration, or bump testing processes.
- Only qualified personnel should zero, calibrate, or bump test a monitor.
- Zero, calibration, and bump testing functions should be performed in a fresh air environment known to be nonhazardous.
- After calibration or bump testing, or after terminating either process, **stop** the flow of gas.

Supplies

Item	Monitor/Regulator**		
	Aspirated monitor with Demand Flow Regulator**	Aspirated monitor with Positive Flow Regulator**	Diffusion monitor with Positive Flow Regulator**
Calibration cup*	No	No	Yes
Calibration tubing 2 feet in length*	Yes	No	Yes
Calibration tubing 2 feet in length with integrated "t" fitting	No	Yes	No
Calibration gas cylinder	Yes	Yes	Yes

*Shipped with monitor.

**Industrial Scientific recommends 1) the use of positive flow regulators with a flow rate of 0.5 LPM, and 2) the diffusion monitor be calibrated or bump tested using a positive flow regulator, *NOT* a demand flow regulator.



Diffusion monitor with positive flow regulator.



Aspirated monitor with demand flow regulator.

Prepare the gas cylinder for use

- According to the supply chart above, attach the correct regulator to the gas cylinder and turn clockwise to tighten.
- Next, choose instruction A., B., or C. based on the monitor/regulator combination in use.

- A. *Aspirated with demand flow regulator*
Attach either end of the tubing to the cylinder's nipple.

DO NOT ATTACH THE OTHER END OF THE TUBING TO THE MONITOR BEFORE REACHING THE "APPLY GAS" SCREEN. Completing the connection of the tubing will cause gas to flow. If gas is applied before reaching the appropriate screen, the monitor will go into alarm and a failure will be logged.

- B. *Aspirated with positive flow regulator*
The calibration tubing with the t-fitting (not included) has two different sized openings, a narrow opening at one end and a wider opening at the other end.
- Attach the wider opening to the nipple on the cylinder's regulator.
 - Attach the smaller opening to the pump inlet.



DO NOT APPLY THE GAS BEFORE REACHING THE "APPLY GAS" SCREEN. If gas is applied before that point, the monitor will go into alarm and a failure will be logged.

C. Diffusion with positive flow regulator

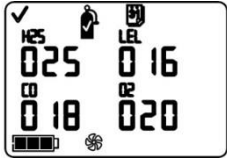
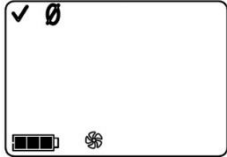

- Attach either end of the tubing to the cylinder's nipple.
- Attach the other end of the tubing to the calibration cup's nipple.

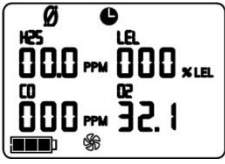
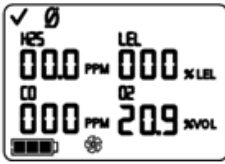
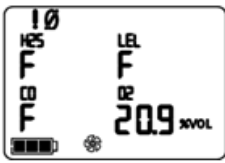

DO NOT ATTACH THE CALIBRATION CUP TO THE MONITOR OR APPLY THE GAS BEFORE REACHING THE "APPLY GAS" SCREEN. If gas is applied before that point, the monitor will go into alarm and a failure will be logged.

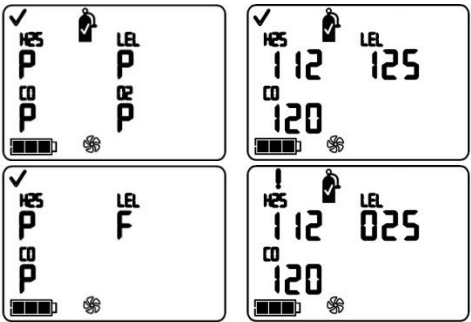
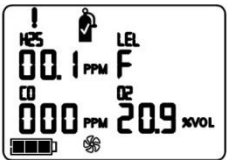
Zero and Quick Calibration Process	
Display and Options	Instructions
 <p>Numeric mode display Text mode display</p> <p>Gas Monitoring Screen Displays the gas concentration readings (or gas names in text mode) for all installed sensors. If a sensor is NOT installed, its position on the LCD is blank.</p>	<p>Press <i>ON/OFF/MODE</i> to advance to the Days Since Calibration Screen.</p>
 <p>Days Since Calibration Screen Displays the number of days since the last successful calibration for each installed sensor. Each value can be different.</p>	<p>Press <i>ON/OFF/MODE</i> to advance to one of three screens.</p> <p>If zero in-field is enabled, the user advances to the Zero Initiate Screen.</p> <p>If zero in-field is disabled and bump test in-field is enabled, the user advances to the Bump Test Initiate Screen.</p> <p>If zero in-field and bump test in-field are both disabled, the user advances to the Peak Readings Screen.</p>
<p><i>Note:</i> When zero, calibration, and bump test are ALL in-field enabled, and the user has entered zero from the gas monitoring mode, the monitor expects to be calibrated following a successful zero.</p> <p>If the desired task, after zero, is bump testing (or clearing the peaks) and NOT calibration, follow the instructions at the <i>Calibration Apply Gas Screen</i> to terminate calibration.</p>	
 <p>Zero Initiate Screen Options: Enter Zero Bypass Zero</p>	<p>Press <i>ENTER</i> to begin the zero process and advance to the Zero In-process Screen.</p> <p>Press <i>ON/OFF/MODE</i> to bypass zero and calibration and advance to one of two screens.</p> <p>If bump test in-field is <i>enabled</i>, the user advances to the Bump Test Initiate Screen.</p> <p>If bump test in-field is <i>disabled</i>, the user advances to the Peak Readings Screen.</p>

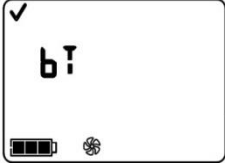
Zero and Quick Calibration Process	
Display and Options	Instructions
 <p>Zero In-process Screen Each sensor's numerical value becomes zero except O₂. An updated O₂ span value displays. The clock icon flashes and the zero icon displays.</p>	<p>Allow the zero process to complete and advance to the Zero Results (Pass or Fail) Screen.</p> <p>After the zero process, press <i>ON/OFF/MODE</i> to bypass calibration of the installed toxic and combustible sensors. The user returns to the mode from which the calibration process was entered (configuration or gas monitoring).</p> <p><i>Note: During the zero process, the O₂ sensor is calibrated (when set to default gas volume of 20.9%)</i></p>
 <p>Zero Results (Pass) Screen The check mark displays to indicate a successful zero and a short beep sounds. Each sensor's numerical values display at zero except O₂.</p> <p>Options: Repeat zero Begin calibration Enter gas monitoring mode</p>	<p>Within Ten Seconds Press <i>ENTER</i> to repeat the zero process. Press <i>ON/OFF/MODE</i> to advance to one of two screens.</p> <p>If zero was entered from...</p> <p>...configuration mode, the user advances to the Calibration Apply Gas Screen.</p> <p>... gas monitoring mode and the calibration in-field option is <i>enabled</i>, the user advances to the Calibration Apply Gas Screen.</p> <p>...gas monitoring mode and the calibration in-field option is <i>disabled</i>, the user advances to the Gas Monitoring Screen in the gas monitoring mode.</p> <p>If neither <i>ENTER</i> nor <i>ON/OFF/MODE</i> is pressed, within ten seconds, the user advances to the Gas Monitoring Screen in gas monitoring mode.</p>
 <p>Zero Results (Fail) Screen Displays an "F" or "P", respectively, for each failed or passed sensor. For O₂, if the sensor passed its calibration, the sensor reading displays.</p>	<p>Press <i>ON/OFF/MODE</i> (or wait ten seconds) to return to the Zero Initiate Screen and repeat the zero process.</p>
 <p>Calibration Apply Gas Screen* The gas cylinder icon flashes. Each sensor's display shows the calibration gas concentration to be applied. (The O₂ display is blank as the sensor was calibrated during zeroing.) The monitor waits up to five minutes to successfully sense the gas.</p>	<p>To Terminate Press <i>ON/OFF/MODE</i> while the gas cylinder icon flashes to terminate the quick calibration process (or to skip a sensor's calibration in standard calibration) and return to the gas monitoring mode.</p> <p>To Calibrate From the prepared gas cylinder, start the flow of gas as noted below for the monitor/regulator combination in use.</p> <p>For an <i>aspirated</i> monitor with a <i>demand flow</i> regulator, complete the tubing connection from the regulator to the pump inlet.</p> <p>For an <i>aspirated</i> monitor with a <i>positive flow</i> regulator, turn (counterclockwise) the regulator's knob.</p>

Zero and Quick Calibration Process	
Display and Options	Instructions
<p>Calibration In-progress Screen*</p> <p>If gas is sensed, the gas values for the LEL and toxic sensors increase and the O₂ value decreases.</p> <p>If gas is NOT sensed, a failed calibration registers and the Calibration Failed Screen displays.</p> <p><i>Note:</i> The “span reserve percentage” of a sensor measures its sensitivity. The displayed span value divided by the calibration gas value equals the span reserve percentage. A span reserve percentage greater than 70% indicates a “good” sensor; 50%-70% indicates “marginal” sensitivity. When the span reserve percentage is less than 50%, the sensor will not pass calibration.</p>	<p>For a <i>diffusion</i> monitor with a <i>positive flow</i> regulator:</p> <ul style="list-style-type: none"> Place the calibration cup over the upper portion of the monitor’s case top (front of monitor). To attach properly, complete or observe the following. <ul style="list-style-type: none"> The cup fully covers the sensor ports. The monitor’s display and buttons are NOT covered. The cup’s side arms fit securely in the grooves on the sides of the monitor. The Ventis name on the calibration cup is upright and readable. The cup’s nipple points up and away from the monitor. Turn the regulator’s knob counterclockwise.
 <p>Sensor Results Screen*</p> <p>Pass (top) or Fail (bottom) Screen</p> <p>The display alternately shows a “P” for pass (or “F” for fail) and the final span value reading for each sensor. A check mark displays and a single beep sounds.</p>	<p>STOPPING THE FLOW OF GAS</p> <p>After calibration, or if calibration is terminated at any time during the process, stop the flow of gas as follows.</p> <p>For an <i>aspirated</i> monitor with a <i>demand flow</i> regulator, disconnect the tubing from the pump inlet.</p> <p>For an <i>aspirated</i> or <i>diffusion</i> monitor with a <i>positive flow</i> regulator, turn (clockwise) the regulator’s knob.</p> <p>All Sensors Pass</p> <p>The user returns to the mode from which the calibration process was entered (configuration or gas monitoring).</p> <p>Sensor Fail</p> <p>If one or more sensors fail calibration, the Calibration Fail Screen displays and a system level alarm turns on.</p>
 <p>Calibration Failed Screen*</p> <p>Gas readings display for all successfully calibrated sensors and an “F” displays for any failed sensors. A system level alarm turns on. The warning icon and gas cylinder display to indicate a sensor calibration failure.</p>	<p>Any failed sensor <i>stays in alarm</i> until it passes a calibration or is replaced.</p> <p>Press <i>ON/OFF/MODE</i> to repeat calibration.</p>
<p>*During the standard calibration or standard bump test process, a series of apply gas, in-progress, and results screens show for EACH sensor as it is calibrated or tested.</p>	

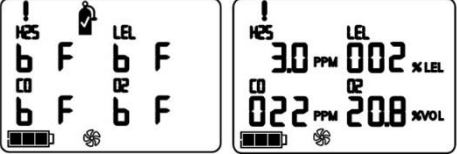
Bump Test Process	
Display and Options	Instructions
 <p>Bump Test Initiate Screen Options Begin process Bypass process</p>	<p>Press <i>ON/OFF/MODE</i> to bypass the bump test process and advance to the Peak Readings Screen.</p> <p>Press <i>ENTER</i> to begin the bump test process.</p>
 <p>Bump Test Apply Gas Screen Displays the bump test gas concentrations the monitor is expecting to receive. The monitor waits up to five minutes to successfully detect the gas.</p> <p>If gas is sensed, the user advances to the Bump Test In-progress Screen.</p> <p>If gas is NOT sensed, a failed bump test occurs and the user advances to the Bump Test Results Screen.</p>	<p>To Terminate Press <i>ON/OFF/MODE</i> while the gas cylinder icon flashes to terminate the quick bump test process (or to skip a sensor's testing in standard bump testing). The user returns to the Gas Monitoring Screen.</p> <p>To Bump Test From the prepared gas cylinder, start the flow of gas as noted below for the monitor/regulator combination in use.</p> <p>For an <i>aspirated</i> monitor with a <i>demand flow</i> regulator, complete the tubing connection from the regulator to the pump inlet.</p> <p>For an <i>aspirated</i> monitor with a <i>positive flow</i> regulator, turn (counterclockwise) the regulator's knob.</p> <p>For a <i>diffusion</i> monitor with a <i>positive flow</i> regulator:</p> <ul style="list-style-type: none"> • Place the calibration cup over the upper portion of the monitor's case top (front of monitor). To attach properly, complete or observe the following. <ul style="list-style-type: none"> ○ The cup fully covers the sensor ports. ○ The monitor's display and buttons are not covered. ○ The cup's side arms fit securely in the grooves on the sides of the monitor. ○ The Ventis name on the calibration cup is upright and readable. ○ The cup's nipple points up and away from the monitor. • Turn the regulator's knob counterclockwise.
 <p>Bump Test In-progress Screen Displays when gas is sensed within five minutes. The clock icon flashes to indicate the test is in-progress. The sensor reading(s) display. The LEL and toxic sensor readings increase and the O₂ reading decreases.</p>	<p>As the bump test progresses, observe the display activity (left). After the bump test, the Bump Test Results Screen displays.</p> <p>STOPPING THE FLOW OF GAS: After bump testing, or if bump testing is terminated at any time during the process, stop the flow of gas from the cylinder as follows.</p> <p>For an <i>aspirated</i> monitor with a <i>demand flow</i> regulator, disconnect the tubing from the pump inlet.</p> <p>For an <i>aspirated</i> or <i>diffusion</i> monitor with a <i>positive flow</i> regulator, turn the regulator's knob clockwise.</p>

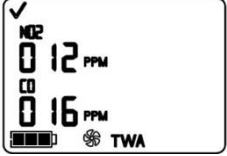
Bump Test Process	
Display and Options	Instructions
 <p>Bump Test Results (Pass) Screen</p> <p>The above displays an all sensor pass result. If one or more sensors fail, the “F” shows in place of the “P”. The pass/fail screen (left) and the final sensor reading screen (right) display alternately three times. A single beep sounds to indicate the bump test is completed.</p>	<p>No User Action Required</p> <p>After a passed bump test, the monitor goes into gas monitoring mode.</p>
 <p>Bump Test Results (Fail) Screen</p> <p>The “b F” displays under each gas type to indicate a bump test failure. The system level alarm turns on and the gas cylinder icon flashes.</p>	<p>After a failed bump test, the Bump Test Fail Screen displays and a <i>low level</i> audio alarm turns on.</p> <p>The monitor should be fully calibrated after a failed bump test.</p> <p><i>Note: After a full calibration, the O₂ sensor must pass a bump test to clear the bump test fail status.</i></p>
 <p>Peak Readings Screen</p> <p>Displays the peak icon and peak gas concentrations for each installed sensor since the last time the peak readings were cleared. (For O₂, the lowest reading is shown.)</p>	<p>Press and release <i>ENTER</i> to clear the peak values, if desired.</p> <p>Press <i>ON/OFF/MODE</i> to advance to one of two screens.</p> <p>If toxic sensors are installed, the user advances to the TWA Readings Screen.</p> <p>If no toxic sensors are installed, the user advances to the Gas Monitoring Screen.</p>
 <p>TWA Readings Screen</p> <p>Displays the TWA (time weighted average) icon and calculated readings for each toxic sensor installed; all other sensor values are blank.</p>	<p>Press and release <i>ENTER</i> to clear the displayed TWA reading(s), if desired.</p> <p>Press <i>ON/OFF/MODE</i> to advance to the STEL Readings Screen.</p>

Bump Test Process	
Display and Options	Instructions
 <p>STEL Readings Screen</p> <p>Displays the STEL (short term exposure limit) icon and STEL values for each toxic sensor installed; all other sensor values are blank. The STEL value is the running average over the last 15 minutes.</p>	<p>Press and release <i>ENTER</i> to clear the reading(s), if desired.</p> <p>Press <i>ON/OFF/MODE</i> to advance to the Gas Monitoring Screen.</p>
<p>*During the standard calibration process, a series of apply gas, in-progress, and results screens show for EACH sensor as it is calibrated or tested.</p>	

Remote Sampling

Aspirated monitor

In confined space, an air sample should be taken in four foot (1.2192 m) intervals.

Guidelines for using a motorized pump and sampling line

WARNING: Do *not* use the *Ventis Slide-on Pump (VSP)* when sampling for these target gases: Chlorine (CL₂), Chlorine Dioxide (CLO₂), Hydrogen Chloride (HCL), and volatile organic compounds (VOC), or when a sensor for any of these gases is installed and the target gas is unknown; use only the *Ventis MX4 Pump Module*. The use of the VSP with these gases will result in inaccurate gas readings due to their susceptibility to absorption.

When sampling with a motorized pump and sampling line, Industrial Scientific recommends the following:

- Never operate a pump without an internal filter installed.
- Choose the tubing type based on the target gases. If the target gases are *known*, use Teflon-lined tubing when sampling for these gases: chlorine (Cl₂), chlorine dioxide (ClO₂), hydrogen chloride (HCl), and volatile organic compounds (VOCs). For other *known* target gases, urethane tubing or Teflon-lined tubing may be used.

When the target gases are *unknown*, use Teflon-lined tubing.
- Know the length of the sample line as it is a factor in determining sampling time. Sample-line length is defined as the distance from the dust filter–water stop opening to the point where the line connects to the pump's inlet. Ensure sample-line length does not exceed the pump's maximum draw.
- A sample line may consist of tubing, a probe, or a probe and tubing.
- Use a dust filter-water stop (external filter) on the sample line, installed at the line's end, in addition to the internal filter within the pump inlet barrel.
- When replacing pump filters*:
 - Replace external and internal filters at the same time.
 - Power-off the instrument prior to changing the filters.
 - Inspect the pump inlet cap and barrel; remove any dirt, debris, or liquid by blowing air through the cap or wiping gently with a clean, lint-free cloth.



Dust filter-water stop

*See also - [Pump cap and internal filter replacement](#).

- Before and after each air sample, perform a test of the full sampling line.
 - Use your thumb to block the end of the sampling line at the water-stop opening. This should cause a pump-fault alarm.
 - Unblock the water-stop opening. After the alarm cycle completes, the pump should resume normal operation.

Note: If a pump fault does *not* occur, check and correct for cracks or other damage, debris, and proper installation in these areas: all sampling line connections, the pump's inlet cap and inlet barrel, and the dust filter-water stop items at the end of the sampling line and inside the pump inlet barrel.

- Based on sample-line length, calculate the *minimum time* recommended for the air sample to reach the instrument's sensors. As shown below, use a base time of 2 minutes, and add 2 seconds for each 30 cm (1 ') of line length. Watch the display screen for gas readings and, if present, allow them to stabilize to determine the reading.

Minimum sample time for common sample-line lengths

Sample-line length	Base time (minutes)	+	Sample-line-length factor (seconds)	=	Minimum sample time (mm:ss)
3.05 m (10')	2 min	+	(10 x 2 s)	=	02:20
6.10 m (20')	2 min	+	(20 x 2 s)	=	02:40
9.14 m (30')	2 min	+	(30 x 2 s)	=	03:00
12.10 m (40')	2 min	+	(40 x 2 s)	=	03:20
15.24 m (50')	2 min	+	(50 x 2 s)	=	03:40
18.29 m (60')	2 min	+	(60 x 2 s)	=	04:00
21.34 m (70')	2 min	+	(70 x 2 s)	=	04:20
24.38 m (80')	2 min	+	(80 x 2 s)	=	04:40
27.43 m (90')	2 min	+	(90 x 2 s)	=	05:00
30.48 m (100')	2 min	+	(100 x 2 s)	=	05:20

Cleaning

- NEVER use solvents or cleaning solutions of any type.
- When necessary, wipe the outside of the Ventis MX4 with a soft, clean cloth.
- Make sure the sensor diffusion membrane, inside and out, is free of debris; wipe gently with a cloth or brush that is soft, clean, and dry.
- Make sure the aspirated monitor's pump inlet is free of debris.

Service

Instructions are provided for battery service; monitor conversion; sensor, sensor barrier and LCD service; and pump assembly service. Refer to the [Ventis MX4 Monitor disassembled view diagram](#) to identify the parts referenced in the instruction sets, and for screw torque values.

Read all instructions before beginning any monitor service.

IMPORTANT

- Before beginning any service tasks, power-off the monitor.
- Only qualified staff should perform monitor service and should take the following precautions.
 - Take care not to touch battery contacts on the monitor or the battery itself.
 - Perform work in a clean air environment that is known to be nonhazardous.
 - Perform work on a nonconductive work surface.
 - Wear grounding straps.

Alkaline battery setup



1. Unlatch and lift the hinged portion of the battery housing.
2. Place AAA battery types Energizer EN92 or Duracell MN2400 so the negative (-) end of the battery, touches the spring inside the battery housing. Do NOT mix battery types.
3. When all three AAA batteries are properly installed, close the battery housing. A “Click” will be heard when the latch catches securely.
4. When replacing batteries, dispose of spent batteries according to company policy.

Aspirated Monitor

The aspirated monitor can be used with two Ventis battery types.

- The Extended range Li-ion battery
- The Alkaline battery

Power off the instrument before disassembling it or performing any service task.

Pump with battery installation



Unscrew and remove the belt clip. Store the clip, screw, and washer for future use.



Unscrew, lift, and remove the battery from the diffusion instrument; store it for future use.



Loosen the pump door screw.



Slide the pump door down.



Lift door to open.

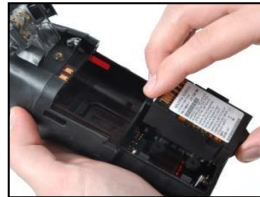

Install a compatible Extended range battery—label side up—into the lower receptacle of the pump case.



Place the instrument in the pump case; tighten* the four torx screws on the back of the pump.



Lower the pump door. Slide it into its fully closed, clicked-shut position.



Tighten* the pump door screw.

Pump door replacement



Loosen the pump door screw. Slide the pump door down; lift it to open.

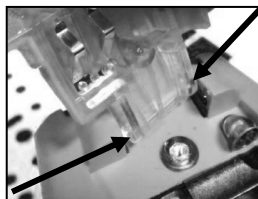

The door is hinged to the pump module with two pegs that slide into grooves. Angle the door so that one peg moves to the bottom of its groove and the other moves the top of its groove. Lift the door to remove it.

Install the new door in the same manner the door was removed.



Lower the pump door. Slide it into its fully closed, clicked-shut position. Tighten* the pump door screw.

*Torque value is .39 Newton-meters (55 ounce-force inch)

Pump cap and internal filter replacement

Important – Power off the instrument prior to performing this service task.



To unscrew and remove the pump cap, turn it in a counterclockwise direction.



Remove the internal filter from the inlet barrel.



Insert the replacement filter in the filter cap (filter P/N 17058157 shown).



Invert the instrument. Place the new internal filter in the inlet barrel of the pump module.

Tip: If the filter does not drop out when you remove the cap, gently tap the side of the instrument.

Inspect the inlet barrel and sealing O-ring in the pump module and filter cap. Ensure that inlet barrel is clean and that both O-rings are in place and free of damage.

Inspect the filter cap inlet and inlet barrel for dirt, debris or liquid. Remove any dirt, debris, or liquid by blowing air through the cap or wiping gently with a clean, lint-free cloth.

Note: Never operate the pump *without* the internal filter.

Secure the pump cap to the inlet barrel: turn the cap in a clockwise direction to tighten.



Diffusion Monitor

The diffusion monitor can be used with all four Ventis battery types:

- The Li-ion battery
- The Slim extended Li-ion battery
- The Extended range Li-ion battery
- The Alkaline battery

Battery installation



Using a torx screwdriver, loosen all four screws from the battery (left) or the battery cover (right).

Lift the battery (left) or battery cover and Extended range battery (right) away from the instrument.

Note: The Extended range battery will easily fit into the battery cover. If the battery does not easily insert, stop to ensure proper placement as noted in the instruction.



To install the Extended range battery, first place the battery in the battery cover. When placed correctly, the battery's label will show.

Next, align the battery cover with the instrument.

To install the battery, align it with the instrument.

Using a torx screwdriver, tighten* each of the four screws to secure the battery (shown) or battery cover to the instrument.

*Torque value is .39 Newton-meters (55 ounce-force inch).

Suspender clip

When worn, the diffusion monitor should be fastened securely and attached to ensure the sensor ports are exposed to the air. The monitor should be in full view. No part of the monitor should be covered by any garment or part of a garment.

Clip replacement

Clip only (use with battery and Slim extended battery)



Lift the clip's cover.



To remove the clip, use a Torx screwdriver to loosen the clip's screw. Turn counterclockwise to loosen.

Remove the screw, washer, and clip; set aside or store for future use.



To attach the clip, put the washer onto the screw and place the screw in the clip's middle hole. Turn the screw clockwise to tighten*.

Clip with spacer (use with Extended battery and battery cover)



To remove the clip, use a Torx screwdriver to access the clip's screw. Turn counterclockwise to loosen the screw.

Remove the washer, screw, clip, and spacer; set aside or store for future use.

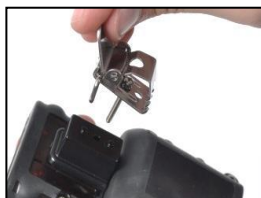

To attach the clip and spacer, cover the case bottom's platform with the spacer.

Put the washer onto the screw and place the screw in the clip's middle hole.



Guide the screw into the spacer's hole and into the instrument case bottom.

Turn clockwise to tighten*.

*Torque value is 0.88 Newton-meters (125 ounce-force inch).

Sensor, Sensor Barrier, LCD, and vibrating motor replacement

Service instruction sets are provided below. Follow the instruction relevant to the desired task and take note of the following:

- The monitor has a two-part circuit board assembly, the main board and a smaller sensor board. They are attached to one another with a connector at the center of the sensor board.
- The sensor barrier can be replaced as an assembly that fits in the monitor's case top, or the full case top can be replaced.
Note: When a sensor is replaced, it is recommended that the sensor barrier/case top also be replaced. After reassembling the monitor, a full calibration should be completed.
- The LCD is removed and attached as a single component.

Disassembling the Monitor. (For the Diffusion monitor start with Step 6.)	
1	Power-off the monitor.
2	Loosen the four captive screws on the lower portion of the pump case module bottom (back of the module).
3	Loosen the single captive screw on the pump case module top.
4	Loosen the front door screw; slide the case door down; lift the hinged door to reveal and access the monitor.
5	Lift and remove the monitor from the pump module; set aside the module.
6	Place the monitor display side down. For a diffusion monitor loosen the four captive battery screws to separate the battery from the case bottom.
7	Loosen the two captive screws on the upper portion of the case bottom.
8	Lift to separate the monitor case top from the monitor case bottom to reveal the circuit board assembly.
9	Remove the circuit board assembly and set aside the monitor case top and bottom.
10	Separate the main circuit board from the sensor board.
Replacing the LCD	
1	Grasp the sides of the LCD and lift straight up to remove from the main circuit board.
2	To properly place the new LCD, align the pins on the LCD with their receptacles on the main circuit board.
3	Gently press straight down and into place.
Replacing the Sensor(s)	
1	Identify the sensor to be removed.
2	Gently lift and remove the sensor.
3	To add the new sensor, align its pins or connector(s), with the respective receptacles on the sensor board.
4	Press down. A slight click indicates the sensor is securely in place.
Reassembling the Circuit Board Assembly	
1	Re-attach the main circuit board to the sensor board, aligning their connectors.
2	Press. A slight click indicates the boards are securely attached.
Replacing the Sensor Barrier or Case Top	
To replace the sensor barrier on the inside of the case top, follow steps 1-5 below. To replace the entire case top, skip to the instruction set, <i>“Reassembling the Monitor”</i> .	
1	Observe the placement of the existing sensor barrier. Note that each cut-out is shaped to match the sensor it protects.
2	Lift and remove the sensor barrier and gasket from inside the monitor case top. Ensure the entire case top is free of adhesive; gently scrape, if needed. Wipe with a clean, dry, soft cloth or brush.
3	Lift the backing from the new sensor barrier assembly to reveal the adhesive.
4	Carefully position the new barrier. Each shaped opening matches the shape of the sensor it protects. Press to attach to the inside of the case top.
Replacing the Vibrating Motor	
1	Place the monitor’s case top face down.
2	Lift the vibrating motor from its partition. The partition has two sections divided by a ridge. Discard the used motor.
3	To properly place the new vibrating motor, its contact pins face the user and align with the left edge of the partition. (The motor’s movable component fits within the small section of the partition.)
4	Press into place.
Reassembling the Monitor	
1	Replace the board assembly into the monitor’s case bottom. The LCD faces the user.
2	Replace the monitor’s case top (or place its new case top).
3	Tighten* the two captive screws on the upper portion of the monitor case bottom.

Reassembling the Monitor (continued)	
4	Replace the monitor inside the pump module. The monitor is display side up and its logo readable. Its lower exposed bottom portion covers the battery. For the diffusion monitor, re-place the battery or battery cover assembly.
5	Tighten* the four screws on the pump module bottom to secure the module to the monitor or tighten* the four captive screws on the battery pack for a diffusion monitor.
6	Close the pump module door; slide up to click in place.
7	Tighten* the pump door screw to secure.
8	Dispose of the used sensor(s) according to company policy.
9	Perform a full calibration following the addition or replacement of any sensor, or the replacement of the sensor water barrier or monitor case top.

*Torque value is 0.39 Newton-meters (55 ounce-force inch).

Ventis MX4 Monitor disassembled view diagram

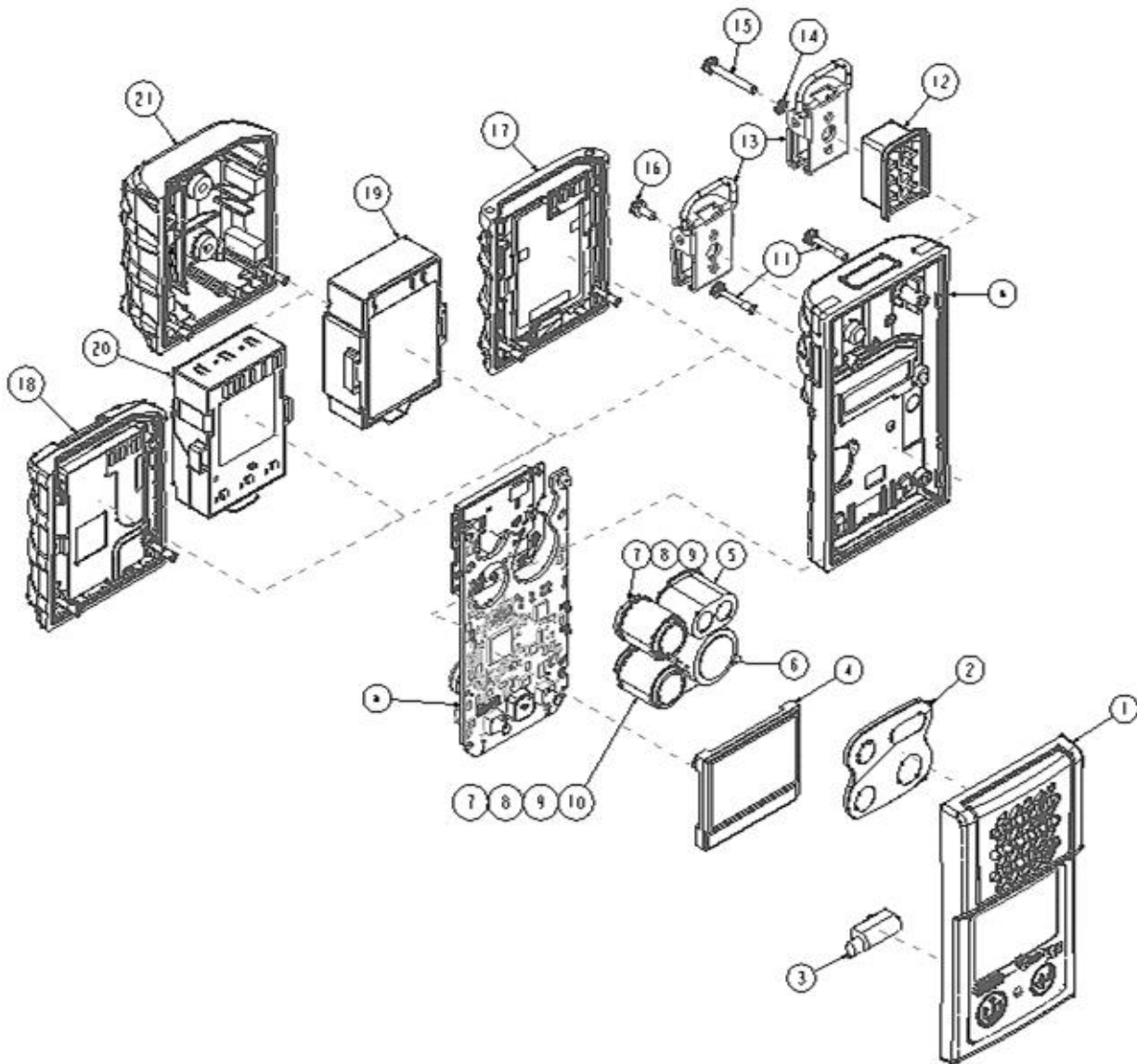

Parts list for Ventis MX4 Monitor disassembled view diagram		
Item	Part Number (P/N)	Description
1	17152380-X	Ventis MX4 Diffusion Case Top Assembly (includes items 2 and 3) X = Case Color, where: 0 = Black, 1 = Orange
2	17152429	Sensor Barrier Assembly
3	17145285	Vibrating Motor
4	17150772	Ventis MX4 LCD Assembly
5	17134495	Ventis MX4 Sensor, Combustible Gas (LEL/CH ₄)
6	17134461	Ventis MX4 Sensor, Oxygen (O ₂)
7	17134487	Ventis MX4 Sensor, Carbon Monoxide (CO)
7	17155564	Ventis MX4 Sensor, Carbon Monoxide/Low Hydrogen cross-sensitivity (CO/H ₂ Low)
8	17134479	Ventis MX4 Sensor, Hydrogen Sulfide (H ₂ S)
9	17134503	Ventis MX4 Sensor, Nitrogen Dioxide (NO ₂)
10	17143595	Ventis MX4 Sensor, Sulfur Dioxide (SO ₂)
11	17147281	Captive Case Screw, Torx (torque value: 55 oz-in or 0.39 N.m +/- 10%)
12	17152506*	Suspender Clip Spacer
13	17120528*	Suspender Clip
14	17153137*	Locking Washer
15	17158281*	Screw, Torx T10 (for use with items 12, 13, and 14) (torque value: 125 oz-in or 0.88 N.m +/- 10%)
16	17158205	Screw, Torx T10 (torque value: 125 oz-in or 0.88 N.m +/- 10%)
Batteries		
17	17134453-XY	Lithium-ion battery
18	17157350-XY	Slim extended lithium-ion battery
19	17148313-Y	Extended range lithium-ion battery
20	17150608-XY	Alkaline battery (CSA, China MA, and China KA approved for diffusion monitor only.)
21	17151184-XY**	Battery cover (for use with Extended range battery)
<p>See Battery part numbers and options for orderable part numbers.</p> <p>Screw Torque: 0.39 newton m (55 ounce-force inch)</p>		
<p>*This Item not user replaceable. The Ventis MX4 monitor must be sent to an authorized Service Center to replace this item. **Available in a conversion kit – VTSB-2XY (orderable part number); when converting an aspirated monitor to a diffusion monitor with a rechargeable Extended range Li-ion battery or Alkaline battery. (<i>Batteries sold separately.</i>)</p>		

Battery Configuration

The base part number that appears on the *label* of a Ventis battery item uses an eight-digit numeric format (XXXXXXXX). The corresponding *orderable* part numbers use the four-letter base reference "VTSB", which is followed by a three character suffix. The first suffix character is a number that designates the battery type; the second and third are used to indicate color and approval options, respectively. For example, as shown below in the *Battery part numbers and options*, a rechargeable Slim extended lithium-ion battery kit that is black and has a UL approval would have an orderable part number of VTSB-401 and its label would state a part number of 17157350-01.

Battery part numbers and options

Diagram number	Battery kit	Part numbers		Options ^a (X and Y)
		Label	Orderable kit	
17	Rechargeable Lithium-ion battery	17134453-XY	VTSB-1XY	X indicates color: 0 for black; 1 for orange Y indicates approvals: 1 for UL, CSA, ATEX, IECEx, EAC (GOST-K and GOST-R), KOSHA, MED, SANS, and TIIS; 2 for MSHA; 3 for China EX; 4 for ANZEx; 5 for INMETRO; and C for China KA
18	Rechargeable Slim extended lithium-ion battery	17157350-XY	VTSB-4XY	
19 and 21	Rechargeable Extended range lithium-ion battery kit (includes battery and cover)	17148313-Y ^c (battery) 17151184-XY (cover)	VTSB-2XY (kit) ^b	
20	Alkaline battery	17150608 ^c	VTSB-3XY	

^aColor and approval options may vary for each battery item. For more information, contact Industrial Scientific or an authorized distributor of its products.

^bThe battery and cover may be ordered separately using these part numbers 17148313-Y (battery) 17151184-XY (cover).

^cAspirated instruments only.

Ventis MX4 Pump module disassembled view diagram

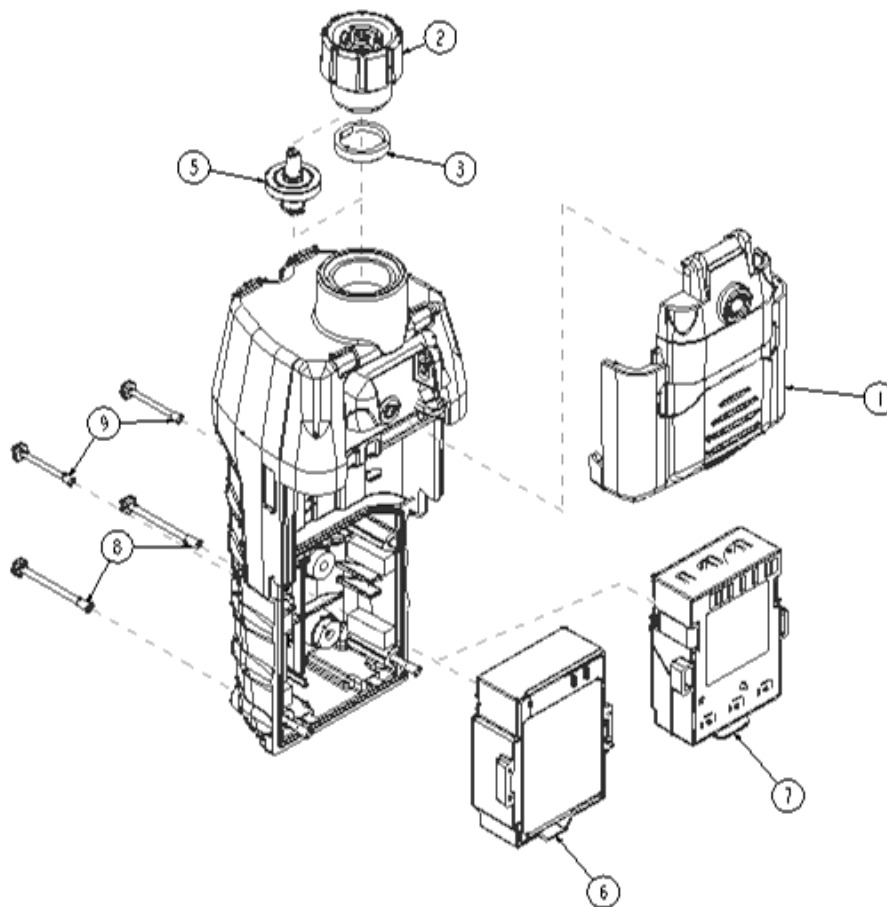

Parts list for Ventis MX4 Pump module disassembled view diagram		
Item	Part Number (P/N)	Description
1	17151150-X0	Ventis MX4 Pump Door Assembly X = Pump Door Assembly Color, where: 0 = Black, 1 = Orange (captive screw torque value: 55 oz. in. or 0.39 n.m. +/- 10%)
2	17129909	Pump Inlet Filter Cap
	17141581	Pump Inlet-Filter Cap for use with 6' extendable probe
	17141599	Filter Cap, 1/8 NPT Female
3	17152395	Water Barrier
5	17058157	Internal Filter
6	17148313-Y	Extended Range Lithium-ion Battery Pack Y = Approval where: 1 = UL, CSA, ATEX, IECEX, INMETRO, GOST-R, GOST-K, KOSHA, and TIIS* 2 = MSHA 3 = China Ex 4 = ANZEx *For TIIS-approved instruments: Do not use for the measurement of oxygen concentrations except for mixtures of air and flammable gas, or vapor and toxic gas. 酸素濃度の測定においては空気と可燃性ガス又は蒸気及び毒性ガスとの混合物以外には使用しないこと
7	17150608	Alkaline Battery: UL, ATEX, IECEX, ANZEx, and INMETRO approvals (CSA, China KA and China MA approved for diffusion monitor only.)
8	17151028	Captive Case Screw, Torx (torque value: 55 oz-in or 0.39 N.m +/- 10%)
9	17151036	Captive Case Screw, Torx (torque value: 55 oz-in or 0.39 N.m +/- 10%)

► Products, Specifications, and Certifications

Ventis MX4 Accessories and Parts

Sensors, Sensor Barrier, Vibrating Motor, LCD, and Calibration Cup	
17134495	Ventis MX4 Sensor, Combustible Gas (LEL/CH ₄)
17134461	Ventis MX4 Sensor, Oxygen (O ₂)
17134487	Ventis MX4 Sensor, Carbon Monoxide (CO)
17155564	Ventis MX4 Sensor, Carbon Monoxide/Low Hydrogen cross-sensitivity (CO/H ₂ Low)
17134479	Ventis MX4 Sensor, Hydrogen Sulfide (H ₂ S)
17134503	Ventis MX4 Sensor, Nitrogen Dioxide (NO ₂)
17143595	Ventis MX4 Sensor, Sulfur Dioxide (SO ₂)
17152380-X	Diffusion Case Top Assembly (includes Sensor Barrier Assembly) X = Case Top Color, where: 0 = Black, 1 = Orange
17152429	Sensor Barrier Assembly
17145285	Vibrating Motor
17150772	Ventis MX4 LCD Assembly
17156189	Ventis Calibration Cup Assembly, calibration cup with tubing
17152455	Ventis Calibration Cup

Monitor Specifications

Item	Description		
Display	Backlit Liquid Crystal Display (LCD)		
Buttons	Two (ON/OFF/MODE and ENTER)		
Monitor case	Polycarbonate with ESD protective rubber overmold		
Alarms	Ultra-bright LEDs, loud audible alarm (95dB at 30 cm), and vibrating alarm		
Size and Weight	Diffusion with Lithium-ion (typical)	Diffusion with Slim extended Lithium-ion (typical)	Aspirated with Extended range Lithium-ion (typical)
Size	103 mm x 58 mm x 30 mm (4.1" x 2.3" x 1.2")	103 mm x 58 mm x 36 mm (4.1" x 2.3" x 1.4")	172 mm x 67 mm x 66 mm (6.8" x 2.6" x 2.6")
Weight	182 g (6.4 oz)	207 g (7.3 oz)	380 g (13.4 oz)

Battery Specifications

The battery specifications table shown below, includes run time, charge time, charging temperature requirements, and expected lifetime.

Battery specifications table

	Rechargeable batteries (part number)			Replaceable batteries (part number)
	Lithium-ion battery (VTSB-1XY ^c)	Slim extended lithium-ion battery (VTSB-4XY ^c)	Extended range lithium-ion battery (VTSB-2XY ^c)	Alkaline battery (VTSB-3XY ^c)
Run time ^a Diffusion	12 hours	18 hours	20 hours	8 hours
Run time ^a Aspirated	–	–	12 hours	4 hours
Charge time ^b	up to 5 hours	up to 7 hours	up to 7.5 hours	–
Ambient temperature required for charging	0 – 40 °C (32 – 104 °F)	0 – 40 °C (32 – 104 °F)	0 – 40 °C (32 – 104 °F)	–

^aApproximate run time when the battery is fully charged and operating at room temperature.

^bWhen a lithium-ion battery becomes deeply discharged and the instrument is docked, it can take up to an hour for the instrument display to indicate that the battery is charging.

^cX indicates color and Y indicates approvals.

Note: Batteries can withstand 300 charge cycles over their lifetime.

Operating Conditions

Warm-up time	40 seconds (includes stabilization time)
Temperature range	-20 °C to +50 °C (-4 °F to +122 °F)
Humidity range	15–95% relative humidity (RH) noncondensing (during continuous operation)
Pressure range	1 atm ±20%

Cold-weather Operation

Use caution when operating the instrument in temperatures below -20 °C (-4 °F), which can diminish display-screen legibility. To help support functionality and available battery power, the following practices are recommended.

- Do not operate the instrument in temperatures that are not within the temperature ranges of the installed sensors (see "Sensor specifications").
- Use a compatible, fully charged lithium-ion battery.
- Before using the instrument in the cold-weather environment, power it in a warm-up environment (approximately 20 °C [68 °F]).
- Alternately operate the instrument in the cold-weather and warm-up environments.
- Do not operate the instrument unmanned.

Storage Conditions

Temperature range	0–25 °C (32–77 °F)
Humidity range	40–70% relative humidity (RH) noncondensing
Pressure range	0.9–1.1 atm
Maximum time	Up to 6 months <i>Note:</i> Industrial Scientific recommends that infrequently used lithium-ion batteries be fully charged every four months.

Sensor Specifications

Gas Name	Abbr	Measuring Range	Resolution	Accuracy at Time and Temperature of Calibration*	Response Time (typical) T50	Response Time (typical) T90
Oxygen	O ₂	0–30% vol	0.1% vol	±0.8% vol O ₂ (0.0–5.0% vol O ₂) ±0.5% vol O ₂ (5.1–30.0% vol O ₂)	15	30
Carbon Monoxide with low H ₂ cross-sensitivity	CO/ H ₂ Low	0–1000 ppm	1 ppm	± 5% (0-300 ppm) ± 15% (301-1000 ppm)	8	17
Carbon Monoxide	CO	0–1000 ppm	1 ppm	± 5%	15	50
Hydrogen Sulfide	H ₂ S	0–500 ppm	0.1 ppm	± 5%	15	30
Nitrogen Dioxide	NO ₂	0–150 ppm	0.1 ppm	± 10%	10	30
Sulfur Dioxide	SO ₂	0–150 ppm	0.1 ppm	± 10%	20	80
Combustible	LEL	0–100% LEL	1% LEL	± 5%	15	35
Methane	CH ₄	0–5% vol	0.01% vol	± 5%	15	35

*The accuracy specification for each sensor is ± the stated percentage or 1 unit of resolution, whichever is greater.

Toxic Gas Sensor Cross-sensitivity Table

Target Gas	Sensor												
	CO	CO (H2 Low)	H2S	SO2	NO2	Cl2	ClO2	HCN	HCl	PH3	NO	H2	NH3
CO	100	100	1	1	0	0	0	0	0	0	0	20	0
H2S	5	5	100	1	-40	-3	-25	10	300	25	10	20	25
SO2	0	5	5	100	0	0	0	—	40	—	0	0	-40
NO2	-5	5	-25	-165	100	45	—	-70	—	—	30	0	-10
Cl2	-10	0	-20	-25	10	100	60	-20	6	-20	0	0	-50
ClO2	—	—	—	—	—	20	100	—	—	—	—	—	—
HCN	15	—	10	50	1	0	0	100	35	1	0	30	5
HCl	3	—	0	5	0	2	0	0	100	0	15	0	0
PH3	—	—	—	—	—	—	-100	425	300	100	—	—	—
NO	25	40	1	1	5	—	—	-5	—	—	100	30	0
H2	22	3	0.1	0.5	0	0	0	0	0	0	0	100	0
NH3	0	0	0	0	0	0	0	0	0	0	0	0	100

The Sensor Cross Sensitivity Table (above) reflects the percentage response provided by the sensor (top row) when exposed to a known concentration of the target gas (column 1).

The numbers were measured under these environmental conditions: 20 °C (68 °F) , 50% RH and 1 atm.

The specified cross-interference numbers apply to new sensors only and may vary with time as well as from sensor to sensor.

“—” means no data available.

This table is given as a reference only and is subject to change.

LEL, and LEL Correlation Factors for Combustible Gases

Sample gas*	LEL (% vol)	LEL correlation factors					
		Calibration gas					
		Butane	Hexane	Hydrogen	Methane	Pentane	Propane
Acetone	2.5%	1.00	0.70	1.70	1.70	0.90	1.10
Acetylene	2.5%	0.70	0.60	1.30	1.30	0.70	0.80
Benzene	1.2%	1.10	0.80	1.90	1.90	1.00	1.20
Butane	1.9%	1.00	0.58	1.78	1.67	0.83	1.03
Ethane	3.0%	0.80	0.60	1.30	1.30	0.70	0.80
Ethanol	3.3%	0.89	0.52	1.59	1.49	0.74	0.92
Ethylene	2.7%	0.80	0.60	1.40	1.30	0.70	0.90
Hexane	1.1%	1.71	1.00	3.04	2.86	1.42	1.77
Hydrogen	4.0%	0.56	0.33	1.00	0.94	0.47	0.58
Isopropanol	2.0%	1.10	0.90	2.00	1.90	1.00	1.20
Methane	5.0%	0.60	0.35	1.06	1.00	0.50	0.62
Methanol	6.0%	0.60	0.50	1.10	1.10	0.60	0.70
Nonane	0.8%	2.22	1.30	3.95	3.71	1.84	2.29
Pentane	1.4%	1.21	0.71	2.15	2.02	1.00	1.25
Propane	2.1%	0.97	0.57	1.72	1.62	0.80	1.00
Styrene	0.9%	1.30	1.00	2.20	2.20	1.10	1.40
Toluene	1.1%	1.53	0.89	2.71	2.55	1.26	1.57
Xylene	1.1%	1.50	1.10	2.60	2.50	1.30	1.60
JP-4	—	—	—	—	—	1.20	—
JP-5	—	—	—	—	—	0.90	—
JP-8	—	—	—	—	—	1.50	—

Note: The table above provides the LEL for select combustible gases*. It also provides correlation factors that help the safety technician and instrument operator determine the actual percentage LEL when the sample gas differs from the gas that was used to calibrate the unit.

For example, if the unit reads 10% LEL in a *pentane* atmosphere, and was calibrated to *methane*, the actual percentage LEL is determined as follows:

1. Locate the table cell where the sample gas (pentane) intersects with the calibration gas (methane).
2. Multiply the cell's value (2.02) by the unit's LEL reading (10%) to calculate the actual concentration of 20.2% LEL.

*The combustible gas list is not a comprehensive list of all combustible gases that can be detected by the Ventis MX4. For additional information about combustible gas detection and the Ventis MX4, contact the Industrial Scientific Technical Service department.

Certifications

Certifications for the **Ventis® MX4 Multi-Gas Monitor**, at the time of this document's publication, are listed below in the *Hazardous-area certifications table*. To determine the hazardous-area classifications for which an instrument is certified, refer to its label or the instrument order.

Hazardous-area certifications table

Certifying Body (CB)	Area Classifications	Approved Temperature Range	Standards
ANZEx	Ex ia s Zone 0 I/IIC, Temperature Class T4	-20 °C to +50 °C (-4 °F to +122 °F)	AS/NZS 60079.0: 2005 AS/NZS 60079.11: 2006 AS/NZS 1826: 2008 IEC 60079-0: 2011 IEC 60079-11: 2011
ATEX ^a	Ex ia IIC, equipment protection level Ga, Temperature Class T4; Ex ia I, equipment protection level Ma; Equipment Group and Category II 1G and I M1	-20 °C to +50 °C (-4 °F to +122 °F)	EN 60079-0:2012+A11: 2013 EN 60079-11: 2012 EN 50303: 2000
China Ex	Ex ia IIC, equipment protection level Ga, Temperature Class T4; Ex ia d I Mb	-20 °C to +50 °C (-4 °F to +122 °F)	GB 3836.1: 2010 GB 3836.20: 2010 GB 3836.4: 2010
China CMC	Metrology approval	-20 °C to +50 °C (-4 °F to +122 °F)	—
China MA	Approved with underground mines with CO, H ₂ S, O ₂ and CH ₄ (Diffusion with 17134453 battery only.)	-20 °C to +50 °C (-4 °F to +122 °F)	—
CSA	Class I, Groups A, B, C, and D, Temperature Class T4 Ex d ia IIC, Temperature Class T4	-20 °C to +50 °C (-4 °F to +122 °F)	CSA C22.2 No. 157 CSA C22.2 No. 152 CSA C22.2 No. 60079-0 CSA C22.2 No. 60079-1 CSA C22.2 No. E60079-11
GOST EAC	PBExiadl X / 1ExiadlIIC T4 X GOST-R Metrology approval, GOST-K Metrology	-20 °C to +50 °C (-4 °F to +122 °F)	GOST P 51330.0 GOST P 51330.1 GOST P 51330.10 GOST P 51330.20 GOST P 24032
IECEX ^a	Ex ia IIC, equipment protection level Ga, Temperature Class T4	-20 °C to +50 °C (-4 °F to +122 °F)	IEC 60079-0: 2011 IEC 60079-11: 2011
INMETRO	Ex ia IIC, equipment protection level Ga, Temperature Class T4	-20 °C to +50 °C (-4 °F to +122 °F)	ABNT NBR IEC 60079-0: 2013 ABNT NBR IEC 60079-11: 2013
KOSHA	Ex d ia IIC, Temperature Class T4	-20 °C to +50 °C (-4 °F to +122 °F)	IEC 60079-0: 2007 IEC 60079-1: 2007 IEC 60079-11: 2006
MASC	SANS 1515-1; Type A; Ex ia I/IIC, Temperature Class T4	-20 °C to +50 °C (-4 °F to +122 °F)	—

Hazardous-area certifications table

Certifying Body (CB)	Area Classifications	Approved Temperature Range	Standards
MSHA ^b	30 CFR Part 22; Permissible for Underground Mines (Lithium-ion packs only)	–	30 CFR Part 22
UL	Class I, Division 1, Groups A, B, C, and D, Temperature Class T4 Class II, Groups F, and G Class I, Zone 0, AEx ia IIC, Temperature Class T4	-20 °C to +50 °C (-4 °F to +122 °F)	UL 913 8 th Ed. UL 60079-0 6 th Ed. UL 60079-11 6 th Ed

^aMarking requirements are reproduced in the *section below*.

^bMSHA requires the monitor be calibrated according to the procedures in the Product Manual only. MSHA also requires the monitor display methane in the percent-by-volume mode (0-5%) for compliance determinations required by 30 CFR Part 75, subpart D.

Marking Requirements

ATEX Markings

Industrial Scientific Corp.
15205 USA
VENTIS MX4
DEMKO 10 ATEX 1006410
Ex ia IIC T4 Ga
Ex ia I Ma
EN 60079-29-1
EN 50104
II 1G and I M1
-20°C ≤ Ta ≤ +50°C
IP 66/67

Aspirated Configuration

Use only replaceable battery pack P/N 17148313-1 or 17050608.
Do Not Recharge or Replace battery in Hazardous Locations.
Charging contact parameters: Um = 6.2V
[Serial Number] [Month/Year of Production]

Diffusion Configuration

Use only replaceable battery pack P/N 17148313-1, 17157350-XX,
or 17134453-X1.
Do Not Recharge or Replace battery in Hazardous Locations.
Charging contact parameters: Um = 6.2V
[Serial Number] [Month/Year of Production]

ANZEx Markings

Industrial Scientific Corp.
15205 USA
VENTIS MX4
ANZEx 11.3006X
Ex ia s Zone 0 I
Ex ia s Zone 0 IIC T4
IP 66/67
-20°C ≤ Ta ≤ +50°C

Aspirated Configuration

Use only replaceable battery pack P/N 17148313-1 or 17050608.
Do Not Recharge or Replace battery in Hazardous Locations.
Charging contact parameters: Um = 6.2V
[Serial Number] [Month/Year of Production]

Diffusion Configuration

Use only replaceable battery pack P/N 17148313-1, 17157350-XX, or 17134453-X1.
Do Not Recharge or Replace battery in Hazardous Locations.
Charging contact parameters: Um = 6.2V
[Serial Number] [Month/Year of Production]

Alkaline Battery Pack, P/N 17150608

Do Not Recharge or Replace battery in Hazardous Locations.
Only approved for use with three (3) AAA battery types Duracell MN2400 and Energizer EN92. Replace all batteries at the same time.

IECEX Markings

Industrial Scientific Corp.
15205 USA
VENTIS MX4
IECEX UL10.0034
Ex ia IIC T4 Ga
-20°C ≤ Ta ≤ +50°C
IP 66/67

Aspirated Configuration

Use only replaceable battery pack P/N 17148313-1 or 17050608.
Do Not Recharge or Replace battery in Hazardous Locations.
Charging contact parameters: Um = 6.2V
[Serial Number] [Month/Year of Production]

Diffusion Configuration

Use only replaceable battery pack P/N 17148313-1, 17157350-XX,
or 17134453-X1.
Do Not Recharge or Replace battery in Hazardous Locations.
Charging contact parameters: Um = 6.2V
[Serial Number] [Month/Year of Production]

Alkaline Battery Pack, P/N 17150608

Do Not Recharge or Replace battery in Hazardous Locations.
Only approved for use with three (3) AAA battery types Duracell MN2400 and Energizer EN92. Replace all batteries at the same time.

► Warranty

All monitors, pumps, and CO, H₂S, O₂, and LEL sensors in Ventis MX4s manufactured after December 31, 2019 are warranted for four (4) years from the device's date of manufacture. All other Ventis MX4 components, including those in devices manufactured before January 1, 2020, are warranted for two (2) years from the device's date of manufacture. The foregoing warranties cover defects in material and workmanship and require normal and proper use of the equipment.

Limitation of Liability

THE WARRANTY SET FORTH ABOVE IS STRICTLY LIMITED TO ITS TERMS AND IS IN LIEU OF ALL OTHER WARRANTIES, GUARANTEES, EXPRESS OR IMPLIED, ARISING BY OPERATION OF LAW, COURSE OF DEALING, USAGE OF TRADE OR OTHERWISE. INDUSTRIAL SCIENTIFIC MAKES NO OTHER WARRANTIES, EITHER EXPRESSED OR IMPLIED, INCLUDING BUT NOT LIMITED TO THE WARRANTIES OF MERCHANTABILITY OR FITNESS FOR PARTICULAR PURPOSE.

SHOULD THE PRODUCT FAIL TO CONFORM TO THE ABOVE WARRANTY, BUYER'S ONLY REMEDY AND INDUSTRIAL SCIENTIFIC'S ONLY OBLIGATION SHALL BE, AT INDUSTRIAL SCIENTIFIC'S SOLE OPTION, REPLACEMENT OR REPAIR OF SUCH NON-CONFORMING GOODS OR REFUND OF THE ORIGINAL PURCHASE PRICE OF THE NON-CONFORMING GOODS.

IN NO EVENT WILL INDUSTRIAL SCIENTIFIC BE LIABLE FOR ANY OTHER SPECIAL, INCIDENTAL, OR CONSEQUENTIAL DAMAGES, INCLUDING LOSS OF PROFIT OR LOSS OF USE, ARISING OUT OF THE SALE, MANUFACTURE, OR USE OF ANY PRODUCTS SOLD HEREUNDER WHETHER SUCH CLAIM IS PLEADED IN CONTRACT OR IN TORT, INCLUDING STRICT LIABILITY IN TORT.

It shall be an express condition to Industrial Scientific's warranty that all products be carefully inspected for damage by Buyer upon receipt, be properly calibrated for Buyer's particular use, and be used, repaired, and maintained in strict accordance with the instructions set forth in Industrial Scientific's product literature. Repair or maintenance by non-qualified personnel will invalidate the warranty, as will the use of non-approved consumables or spare parts. As with any other sophisticated product, it is essential and a condition of Industrial Scientific's warranty that all personnel using the products be fully acquainted with their use, capabilities, and limitations as set forth in the applicable product literature.

Buyer acknowledges that it alone has determined the intended purpose and suitability of the goods purchased. It is expressly agreed by the parties that any technical or other advice given by Industrial Scientific with respect to the use of the goods or services is given without charge and at Buyer's risk; therefore, Industrial Scientific assumes no obligations or liability for the advice given or results obtained.

► Ventis MX4 Resource Center

Product documentation.
Online training.
And more!
www.indsci.com/ventis

Contact Information

Industrial Scientific Corporation

1 Life Way
Pittsburgh, PA 15205-7500 USA
Web: www.indsci.com
Phone: +1 412-788-4353 or 1-800-DETECTS (338-3287)
E-mail: info@indsci.com
Fax: +1 412-788-8353

Industrial Scientific France S.A.S.

11D Rue Willy Brandt
62002 Arras Cedex, France
Web: www.indsci.com
Phone: +33 (0)1 57 32 92 61
E-mail: info@eu.indsci.com
Fax: +33 (0)1 57 32 92 67

英思科传感仪器（上海）有限公司

地址：中国上海市浦东金桥出口加工区桂桥路290号
邮编：201206
电话：+86 21 5899 3279
传真：+86 21 5899 3280
E-mail： iscapinfogroup@indsci.com
网址： www.indsci.com
服务热线：+86 400 820 2515

To locate a nearby distributor of our products or an Industrial Scientific service center or business office, visit us at www.indsci.com.

Rendez-vous sur notre site Web www.indsci.com, si vous voulez trouver un distributeur de nos produits près de chez vous, ou, si vous recherchez un centre de service ou un bureau Industrial Scientific.

Besuchen Sie uns unter www.indsci.com, um einen Vertriebshändler unserer Produkte oder ein Servicecenter bzw. eine Niederlassung von Industrial Scientific zu finden.

Para buscar un distribuidor local de nuestros productos o un centro de servicio u oficina comercial de Industrial Scientific, visite www.indsci.com.

如需查找就近的产品经销商或 Industrial Scientific 服务中心或业务办事处，请访问我们的网站 www.indsci.com。

INDUSTRIAL SCIENTIFIC