

**NEED HELP?**

**SCAN OR CLICK HERE  
TO CONTACT US**



**Air-Met Scientific**  
[www.airmet.com.au](http://www.airmet.com.au)



**SCARLET | TECH**

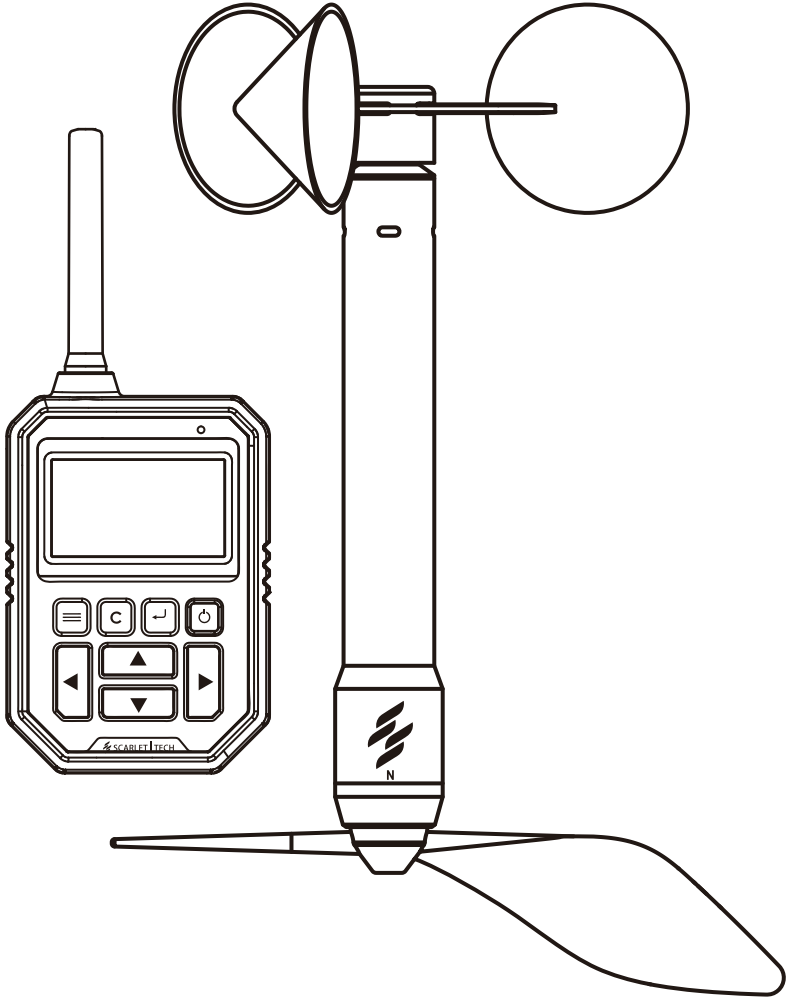

# **WL-21**

## **Wireless Anemometer**

### **User Guide**

# Page Contents

---

<b>Introduction</b>	<b>2</b>
<b>Sensor &amp; Receiver</b>	<b>3</b>
<b>Sensor</b>	3
Wireless connection	3
Transmission range	3
Wind direction measurement	3
<b>Receiver</b>	4
Keypad	5
<b>Installation Guide</b>	<b>6</b>
<b>Navigation Diagram</b>	<b>7</b>
MAIN page	8
AVG/MAX page	9
CHART page	9
HISTORY page	10
SETTINGS page	11
WIND SPEED settings page	11
WIND DIRECTION settings page	12
DATA LOGGING settings page	13
GENERAL settings page	14
<b>Functions</b>	<b>15</b>
Sensors pairing	15
Time and measurement units setting	15
Wind direction correction	16
Wind speed alarm	17
Data logging	17
Data export	18
Power saving mode	20
Power off	20
<b>Technical Specification</b>	<b>21</b>
Wireless sensor	21
Receiver	21
Wind speed sensor	22
Temperature sensor	22
Atmospheric pressure sensor	22
<b>Packing Content</b>	<b>23</b>
<b>Safety, Maintenance, &amp; Warranty</b>	<b>25</b>

# Introduction

---

WL-21 is a high-performance wireless wind speed and direction data logger for industrial applications and long-term environmental monitoring. It consists of a long-range wireless wind speed and direction sensor (up to 500 meters) and a portable datalogger display.

The system measures and displays current/average/maximum wind speed, wind direction, temperature, wind chill, Beaufort scale, atmospheric pressure, and historic data graphic in high accuracy with multiple measurement units. Users are able to set wind speed threshold and receive instant alarm notification when wind speed exceeds the set threshold.

WL-21 also supports data logging and can export data in excel format to computers by using a micro USB output.



# Sensor & Receiver

---

## ■ Sensor

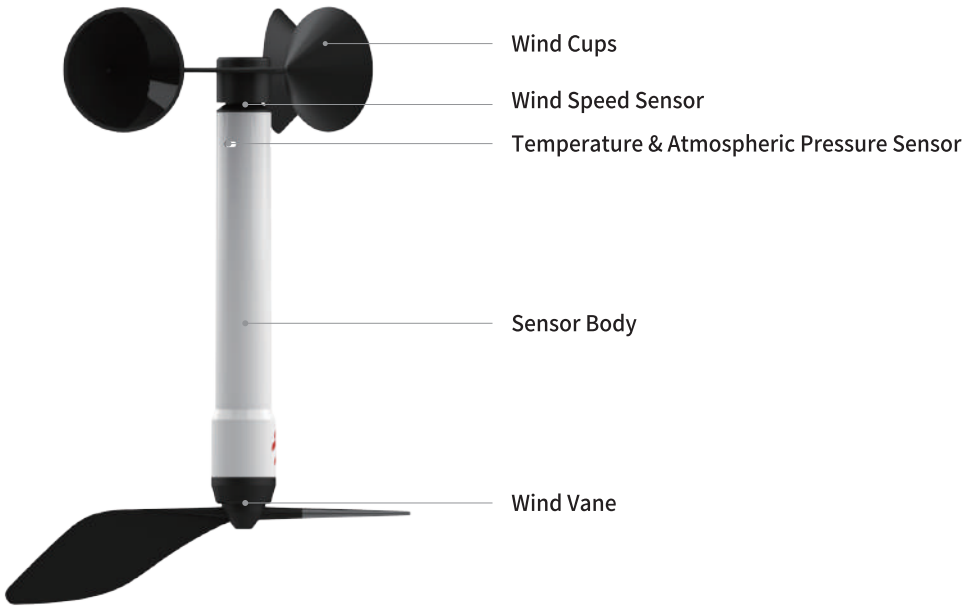

## Wireless Connection

Each sensor has a unique wireless address number that has been pre-paired corresponding to the receiver display. One sensor can be connected to multiple receivers. Several anemometers can operate in close proximity without disturbance.

## Transmission Range

The connection between sensor and receiver goes through Sub-1GHz wireless band (868, 915 MHz). The signal strength is shown on the receiver MAIN page. The transmission range between the sensor and the receiver can reach up to 500 meters in a direct line of sight. Inside buildings or obstacles in between may decrease the transmission range.

## Wind Direction Measurement

WL-21 Sensor equips with a wind vane that measures the direction where the wind originates. The wind vane features a metal pointer front and a tail in the back. In a north wind, the wind vane points northward, and the display reads as N and 0°.

## Receiver



# Keypad



icon	Name	Functions
	Power	Power ON / OFF
	Settings	Go to Main / Settings page
	Enter	Select; Confirm
	Cancel	Cancel; Go back to the previous page
	Up	Up; Increase number; Change option
	Down	Down; Decrease number; Change option
	Left	Previous page
	Right	Next page

# Installation Guide

## ■ Sensor Installation

WL-21's package comes with a Magnetic Sensor Mounting Bracket that supports fast and flexible installation.

1. Loosen the clamp
2. Insert the sensor body from the bottom of the clamp
3. Tighten the clamp
4. Apply wind cups on wind sensor rotation shaft
5. Make sure you hear a "CLICK" sound that indicates all parts are locked in place.
6. Attach the bracket on the desired magnetic surface

*Note: Always do orientation correction after deploy the wind sensor. (see Wind Direction Sensor Correction, P16)*

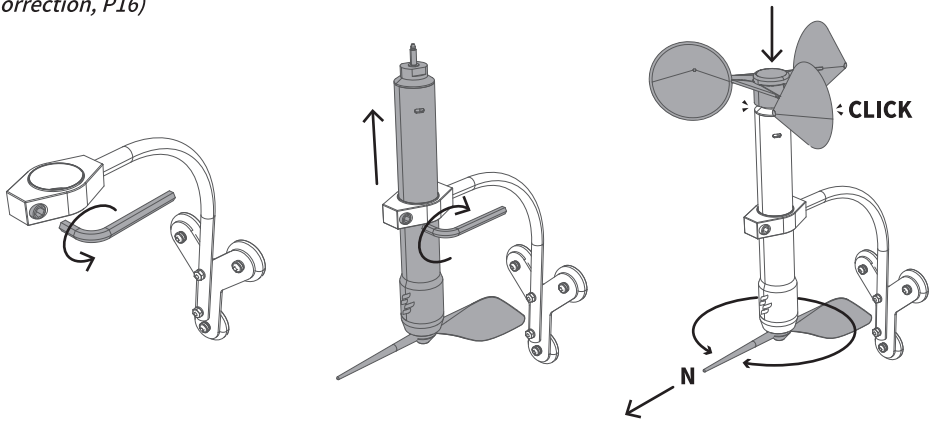

## ■ Receiver Installation

WL-21's Receiver Holder Kit comes with an anti-slip display holder with neodymium magnets on both ends and three pieces of adhesive metal flakes.

1. Peel off the backing paper of the metal flake to reveal the adhesive side
2. Press and stick the adhesive side of the metal flake to the Receiver's back cover
3. Attach the Receiver to the display holder magnetically

You can attach the receiver holder on any magnetic surface or adhere the metal flake on the non-magnetic surface first before attaching the magnetic display holder.

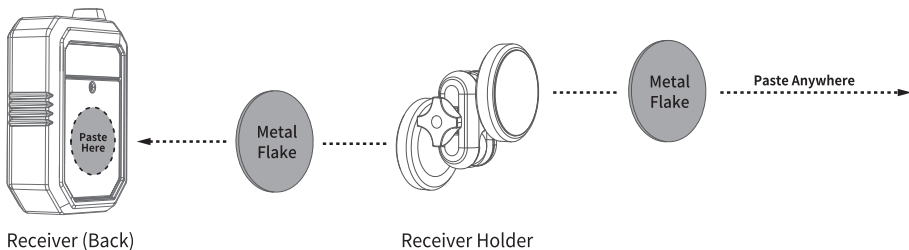

# Navigation Diagram

---

After Receiver is powered on, the receiver will enter the MAIN page. Users can press Right/Left and Settings/Cancel buttons to navigate through the pages.

↔ : Switching by **Right** and **Left** buttons

●—● : Switching by **Settings** and **Cancel** buttons

←—> : Switching by **Enter** and **Cancel** buttons

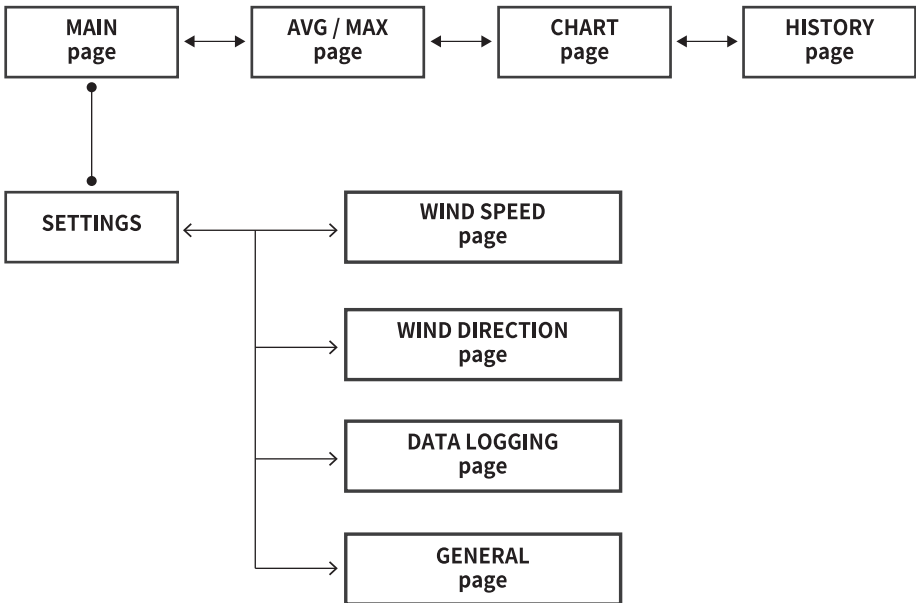



## ■ MAIN page

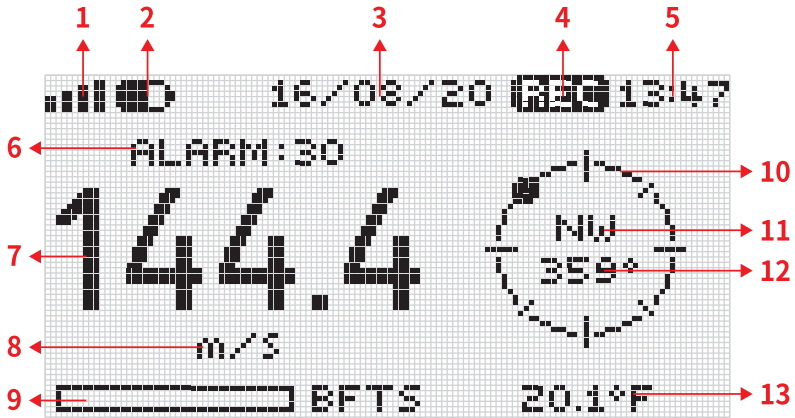

Number	Name	Definition
1	Signal Strength	The wireless signal strength between sensor and receiver
2	Receiver Power	Receiver battery level or power supply through micro USB 
3	Date	Current date in DD/MM/YY
4	Data Logging	Indicate the data logging function is turn ON
5	Time	Current time in HH:MM (24hr military time)
6	Wind Alarm Threshold	The set wind speed alarm trigger threshold
7	Wind Speed	Current wind speed
8	Wind Speed Unit	Set wind speed unit (m/s, km/hr, MPH, knots)
9	Beaufort Scale	Beaufort wind force scale (unit BFTS, 12 levels in total)
10	Wind Direction Indicator	A azimuth diagram with a dot that indicate where the current wind is from. (8 directions, North at the top)
11	Wind Direction (Cardinal Direction)	Current wind direction in E, W, S, N, SE, NE, SW, NW
12	Wind Direction (Degrees)	Current wind direction in degrees, N=0°, E=90°, S=180°, W=270°
13	Temperature	Current temperature (Unit: °C, °F)

## ■ AVG/MAX page

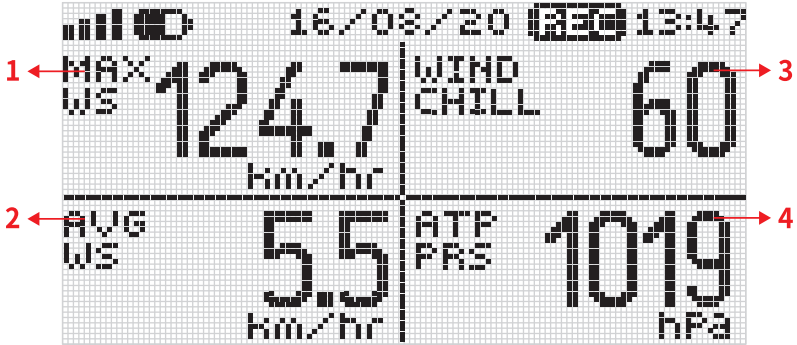

Item	Name	Definition
1	Maximum Wind Speed	Maximum wind speed for the past 12 hours since receiver turns on (display after the first hour)
2	Average Wind Speed	Average wind speed for the past 12 hours since receiver turns on (display after the first hour)
3	Wind Chill	Current wind chill index
4	Atmospheric Pressure	Current atmospheric pressure

## ■ CHART page

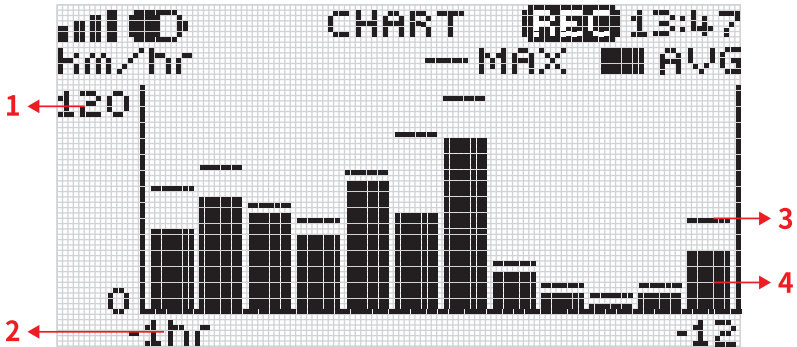

Item	Name	Definition
1	Wind Speed Value	Show wind speed value. (0 to max selectable unit)
2	Time	Show the past 12 hours from the current time (from -1 to -12, one column represents an hour)
3	Maximum Wind Speed	Maximum wind speed in the time period
4	Average Wind Speed	Average wind speed in the time period

**HISTORY page**

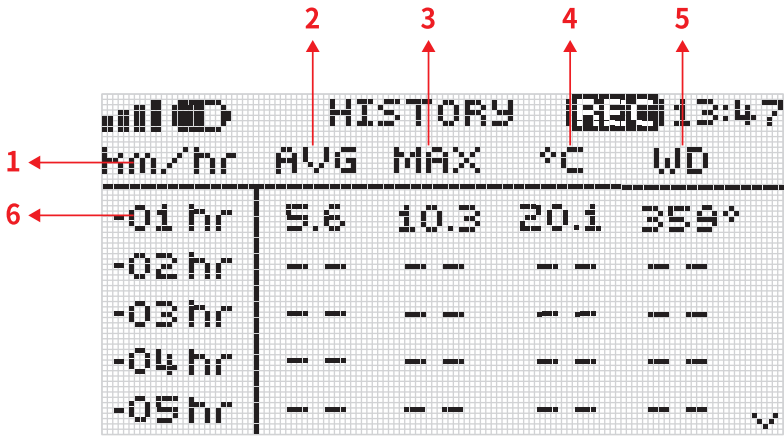

Item	Name	Definition
1	Wind Speed Unit	Set wind speed unit (m/s, km/hr, MPH, knots)
2	Average Wind Speed	Average wind speed of the corresponding period
3	Maximum Wind Speed	Maximum wind speed of the corresponding period
4	Average Temperature	Average temperature of the corresponding period
5	Average Wind Direction	Average wind direction of the corresponding period
6	Time Period	The past 12 hours of wind data from the current time (from -1 to -12)

## ■ SETTINGS Page



Item	Name	Definition
1	Wind speed page	Wind speed and alarm setting
2	Wind direction page	Wind direction setting and correction of wind direction
3	Data logging page	Data logging setting and management
4	General page	General setting page
5	Version	Current receiver firmware version info

## ■ WIND SPEED settings page

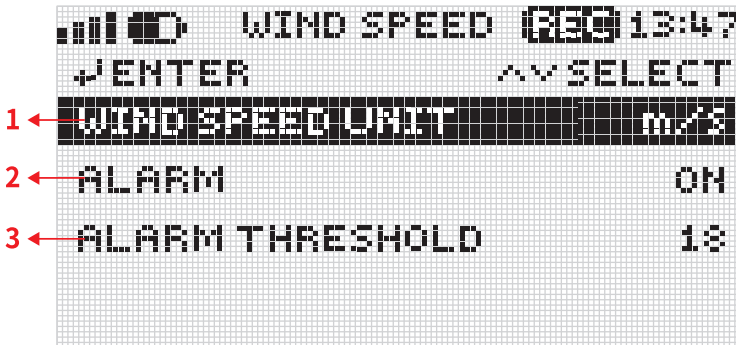

Item	Name	Definition
1	Wind Speed Unit	Wind speed measurement unit: m/s (default), km/hr, MPH, knots
2	Alarm	Wind speed alarm function: ON (default) /OFF
3	Alarm Threshold	Wind speed alarm threshold: 1 to 180 at selected unit, (default: 18)

## ■ WIND DIRECTION settings page

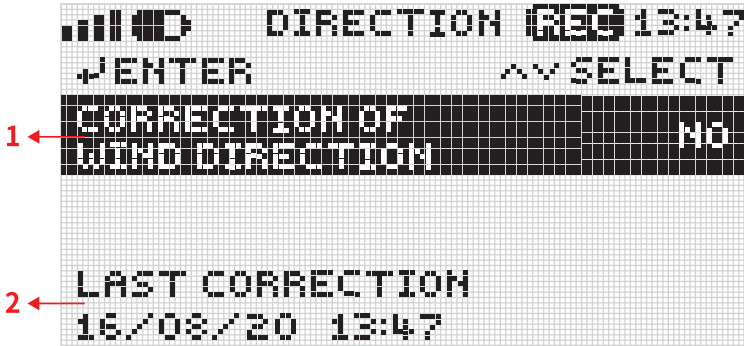

Item	Name	Definition
1	Correction of Wind Direction	Set default North of Wind direction sensor
2	Last Correction	The date & time that the wind direction sensor was set

## DATA LOGGING settings page

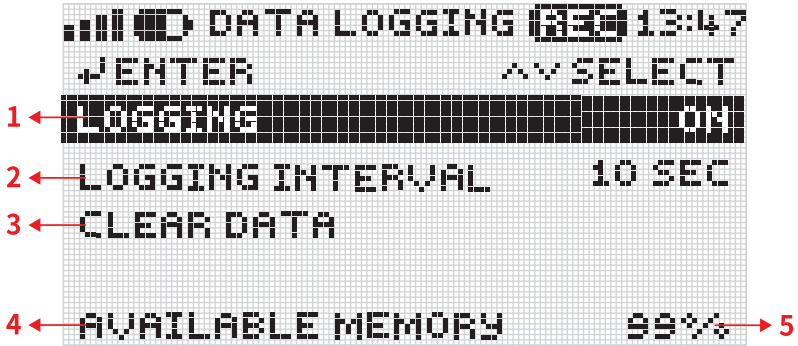

Item	Name	Definition
1	Logging	Logging function: ON / OFF(default)
2	Logging interval	Data logging interval: 2 sec, 5 sec, 10 sec (default), 1 min, 5 min, 10 min, 60 min
3	Clear data	Clear all data to release the memory
4 & 5	Available memory	Remaining data storage space in percentage

## GENERAL settings page

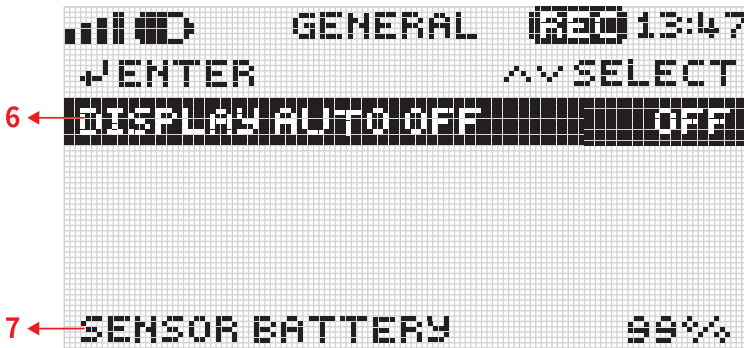
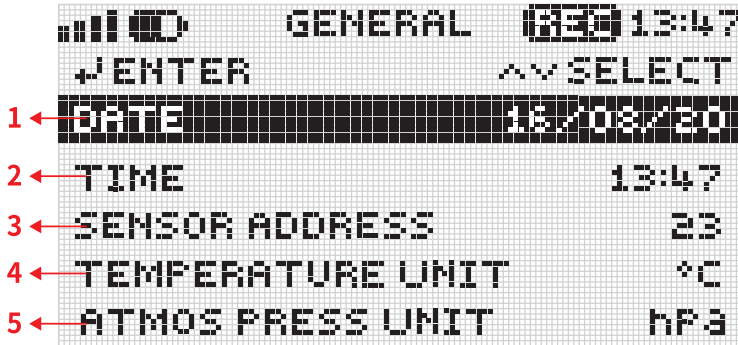

Item	Name	Definition
1	Date	Set current date. DD/MM/YY
2	Time	Set current time. HH:MM (24hr military time)
3	Sensor Address	Set the wireless sensor address number that connected to this receiver
4	Temperature unit	Unit for temperature measurement: °C (default), °F
5	Atmospheric pressure unit	Unit for atmospheric pressure measurement: hPa (default), mm Hg, bar
6	Display auto off	Display automatically switch to power saving mode after the set idle period: OFF (default), 5 min, 10 min, 30 min
7	Sensor Battery	Battery power percentage of the wireless sensor

# Functions

## Sensors Pairing

The wireless address number is labelled on the sensor body, as well as in the setting of each receiver.

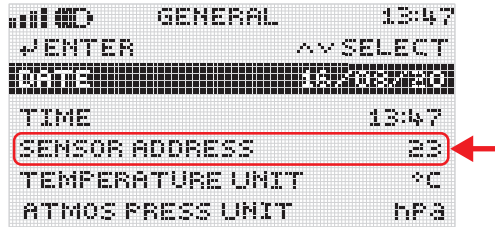
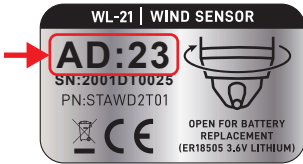

### Change receiver wireless address:

1. Press Settings button go to SETTINGS page
2. Press Enter on GENERAL to go to GENERAL setting page
3. Press Up/Down to move the selection cursor to SENSOR ADDRESS, and then press Enter to modify pairing address.
4. When the address number is blinking, press Up/Down to change the number to the desired sensor address, and then press Enter to confirm.
5. When the sensor and receivers are wirelessly connected, the receiver's LED indicator will beep twice and flash GREEN light twice.

*When the wireless connection between sensor and receiver is lost for over 10 minutes, the LED indicator will flash red light every 10 seconds.*

## Time and Measurement Units Setting

### Change date, time, temperature unit, atmosphere pressure units:

1. Press Settings button go to SETTINGS page
2. Press Enter on GENERAL to go to GENERAL setting page
3. Press Up/Down and Enter to select and change the section unit

### Change wind speed measurement unit:

1. Press Settings button go to SETTINGS page
2. Press Enter on WIND SPEED to go to WIND SPEED setting page
3. Press Enter on Wind SPEED UNIT
4. Press Up/Down and Enter cursor to select the unit: m/s (default), km/hr, MPH, knots



## Wind Direction Correction

Please refer to the following steps to correct the default orientation. Always do correction after wind sensor deployment.

1. Turn on Receiver, press Settings button to go to SETTINGS page
2. Press Up/Down to move the selection cursor to WIND DIRECTION, and then press Enter to go to WIND DIRECTION settings page. Wait a few seconds for Receiver-Sensor connection.
3. Press Enter on CORRECTION OF WIND DIRECTION to start orientation correction. Follow the instruction on the screen, orient the Sensor's wind vane pointer to the True North.
4. Press Enter on CONFIRM to determine North direction in WL-21.
5. The LAST CORRECTION date will be updated when orientation correction succeeds.

*Please make sure the Sensor and Receiver are wirelessly paired throughout the wind direction correction. (see Sensors Pairing). If the Receiver fails to connect with the Sensor during the process, users will be back to the SETTINGS page and need to set it again.*

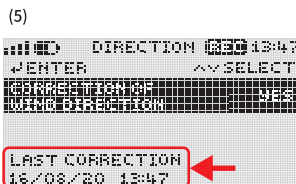
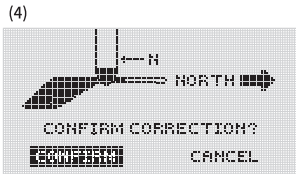
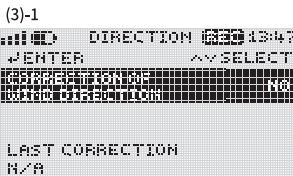

(3)-2



## ■ Wind Speed Alarm

WL-21 Receiver's built-in buzzer will be triggered when the wind speed exceeds the set threshold. The display backlight flashes AMBER and LED indicator continuously blinks in RED.

### Set alarm threshold:

1. Press Settings button go to SETTINGS page
2. Press Enter on WIND SPEED to go to WIND SPEED setting page
3. Press Enter on ALARM THRESHOLD
4. Press Up/Down and Enter to set the wind speed alarm threshold

### Turn on alarm function:

1. Press Settings button go to SETTINGS page
2. Press Enter on WINDSPEED to go to WINDSPEED setting page
3. Press Enter on ALARM
4. Press Up/Down to select ON and press Enter to confirm the setting.

## ■ Data Logging

WL-21 Receiver is equipped with a 64MB built-in memory that is capable of recording average wind speed, maximum wind speed, average wind direction, average air temperature, average atmospheric pressure during the selected logging interval.

### Set Logging Interval: (default interval: 10 seconds)

1. Press Settings button go to SETTINGS page
2. Press Up/Down and Enter to go to DATALOGGING setting page
3. Press Enter on LOGGING INTERVAL, and press Up/Down to select desired logging interval (Supported logging interval: 2 sec, 5 sec, 10 sec, 1min, 5min, 10min, 60 min)

*Logging interval can only be altered while the datalogging function is OFF.*

### Start Logging:

1. Go to DATA LOGGING setting page (see steps above)
2. Press Enter on LOGGING
3. Press Up/Down cursor to select ON
4. Select YES to confirm to start data logging
5.  will display on screen the top left corner to indicate the data logging function is ON

*When the data logging function is ON, the receiver cannot be turn OFF.*

### Finish Logging:

1. Go to LOGGING setting (see steps above)
2. Press Up/Down cursor to select OFF
3. Select Yes to confirm to stop data logging
4. A logged file will be created and stored at receiver when the logging status switch from "ON" to "OFF"

There are 2 conditions which will automatically turn the data logging function OFF:

- The battery level of the receiver is under 5%.
- There is no available memory space in the receiver

*For long-term data recording, Scarlet recommends to supply the receiver power through micro USB cable or make sure the battery power for receiver is sufficient for the entire logging period.*

## ■ Data Export

To export the logged file from receiver, use your Windows PC to install the Data Export Software, “ScarletWind”.

### 1. Download and unzip “ScarletWind.zip” file to your PC from Scarlet’s website.

<https://scarlet-tech.com/wp-content/uploads/ScarletWind/ScarletWind.zip>

### 2. Connect the receiver to PC via micro USB cable

*Make sure the datalogging feature is turned OFF (see Finish Logging)*

**A new USB device will show up on your devices list indicates the receiver is connected to your computer**

### 3. Double click to run the data export software “ScarletWind”

### 4. Select the COM Port of your receiver\* then press “Download” button

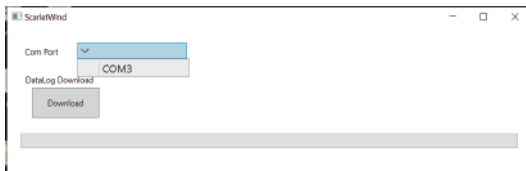

### 5. Select the destination folder for the log files

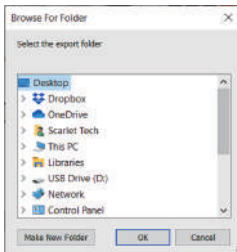

### 6. Select the export file type (.xlsx or .xls)

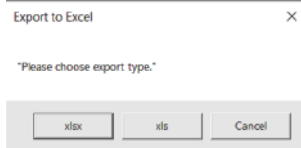

### 7. WL-21 will start exporting the logged files.

*Receiver will display “Data Downloading” during the process.*

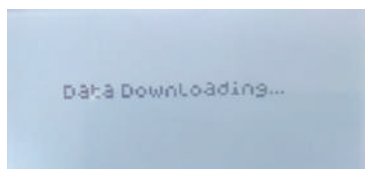
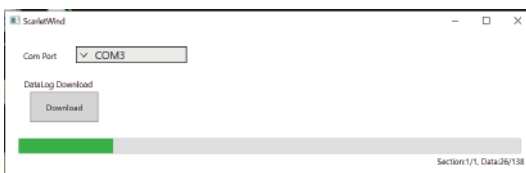

## 8. Wait for the “Finish” pop-up that indicates the data exporting is complete

Depending on the data amount and PC performance, the time will vary from a few minutes up to half an hour.

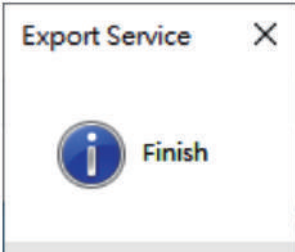

*\*Please update the USB driver if the COM port is unidentified.*

1. Go to “Device Manager”
2. Select the update the “Unknown Device” (or “USB Serial Port”) with exclamation mark.
3. Right-click to update driver

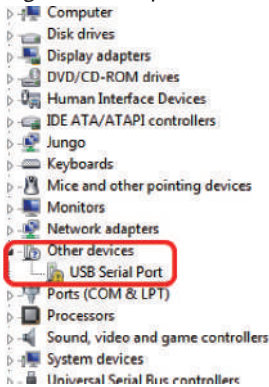

4. Select the driver software “NuvotonCDC” in the receiver USB drive to update

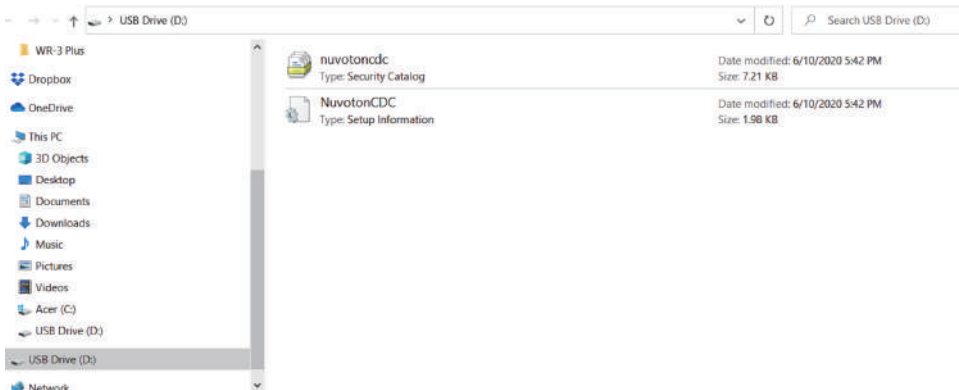

## ■ Power Saving Mode

In power saving mode, the receiver display will temporary turn off to reduce power consumption and the LED indicator will light GREEN every 10 seconds. All function remains working, includes alert and logging. While the wind speed alarm function is ON, the buzzer will be triggered while wind speed exceeds the set threshold.

### **Enable power saving mode:**

1. Press Settings button go to SETTINGS page
2. Press Enter on GENERAL and Down to go to the 2nd page of GENERAL setting
3. Press Enter to select DISPLAY AUTO OFF
4. Press Up/Down cursor to set the idle period: 5min, 10min, 30min

*The receiver display will automatically turn off after the set idle period to save battery power. The display will resume when any key is pressed.*

## ■ Power Off

1. Press Settings button go to MAIN page
2. Long press the power button for 5 seconds

*When the data logging function is ON, the Receiver cannot be powered-off by pressing power button directly.*

# Technical Specifications

---

## Wireless Sensor

Item	Definition
Frequency	868MHz, 915MHz
Distance	Max 500m* (depends on the applied environment)
Data Rate	Every 2 seconds
Power Supply	3.6V 18505 Lithium battery x1
Waterproof Rating	IP67
Weight	172g
Dimension	203 x 300 x32 mm

## Receiver

Item	Definition
Receiver Buzzer	> 80dB
Built-in Memory	64MB
Output	.xlsx, .xls
Data Logger	Average wind direction Average wind speed Maximum wind speed Average temperature Average atmospheric pressure
Logging Interval	2 seconds, 5 seconds, 10 seconds (default), 1 minute, 5 minutes, 10 minutes, 60 minutes
Power Supply	1.5V AA battery x3 Micro USB port
Dimension	189.6 x 75.6 x 36.3mm
Weight	290g

## Wind Speed Sensor

Item	Definition
Measurement Unit	m/s (default) knots MPH km/hr
Measurement Range	0.3...50 m/s
Measurement Resolution	0.1 m/s 0.1 knots 0.1 MPH 0.1 km/hr
Measurement Accuracy	±2% FS

## Wind Direction Sensor

Item	Definition
Measurement Range	0...359° no blank sector
Measure Resolution	1°
Measurement Accuracy	±1°

## Temperature Sensor

Item	Definition
Measurement Unit	°C (default) °F
Measurement Range	-30°C...60°C
Measurement Resolution	0.1°C 0.1°F
Measurement Accuracy	±1°C

## Atmospheric Pressure Sensor

Item	Definition
Measurement Unit	hPa (default) mmHg bar
Measurement Range	500...1100 hPa
Measurement Resolution	1 hPa 0.1 mmHg 0.001 bar
Measurement Accuracy	±4 hPa

# Package Content

---

- Wireless Sensor
- Wind Cups
- Receiver
- Receiver Antenna
- Receiver Holder
- Adhesive Metal Flakes x 3 (for Receiver Holder installation)
- Magnetic Sensor Mounting Bracket
- AA Battery x 3 (for Receiver)
- 3.6V 18505 Lithium battery x1 (placed in Sensor)
- User Manual & Certificate



Wireless  
Sensor



Wind Cups



Receiver



Receiver  
Antenna



Receiver Holder &  
holder kit



Magnetic Sensor  
Mounting Bracket



AA Battery x 3  
(for Receiver)



3.6V 18505  
Lithium battery x1  
(placed in Sensor)

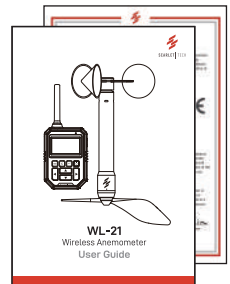

User Manual & Certificate



## Optional Accessories

- Spare Wind Cups
- Spare Sensor Battery (3.6V 18505 Lithium battery)
- External Antenna



Wind Cups



3.6V 18505 Lithium battery x1  
(placed in Sensor)

# Safety, Maintenance, & Warranty

## Operating Environment

The operating temperature of the anemometer system is designed to work in an ambient temperature between 5°C to 60°C (40°F to 140°F) at 20~80%RH. The storage temperature is between -20°C to 60°C (-4°F to 140°F). The instrument can be damaged if stored and operated outside of these temperature ranges. Avoid exposing the instrument to extreme changes of weather and or temperature in a continuous short period of time.

## Sensor Battery Replacement

The wireless sensor is powered by a 3.6V 18505 Lithium battery. Its battery can be check by the Receiver (See GENERAL settings page)

- Turn the battery cap near the wind vane counter clockwise to remove it.
- Take out the battery container from the sensor.
- Replace the battery with a new 3.6V 18505 Lithium battery.

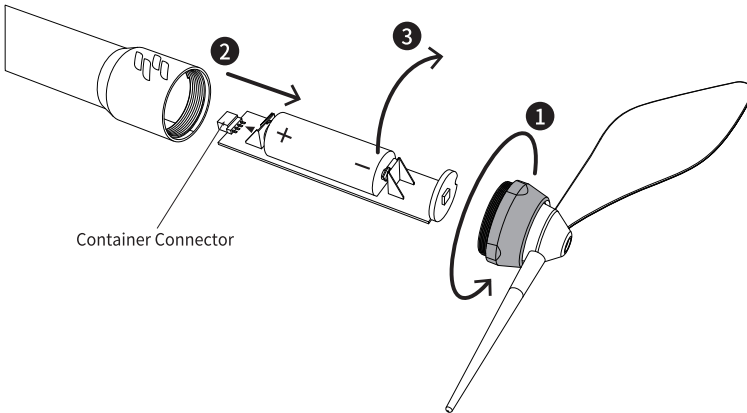

- Put back the battery container into the sensor (Please note the placement direction).

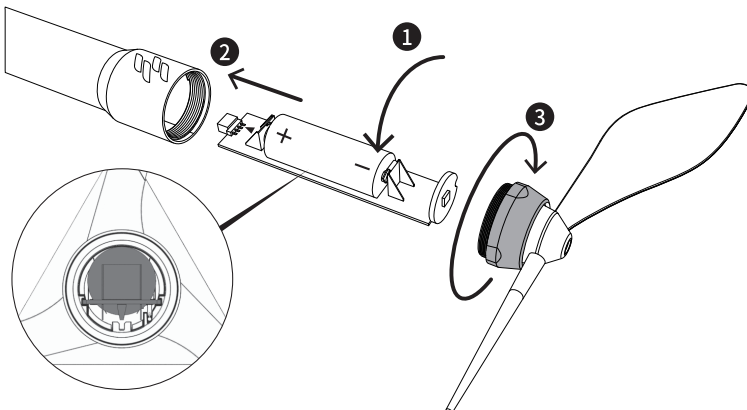

- Make sure the O-ring is correctly aligned to the battery cap for waterproof protection.
- Put back the battery cap in clockwise direction to finish the battery changing.



## Receiver Battery Replacement

The receiver is powered by 3 AA 1.5V batteries. The battery level is displayed on the top of the display.(See MAIN page)

- Remove the screw and then remove the battery cover on the back.
- Replace the batteries with 3 new 1.5V AA batteries.
- Place back the battery cover and fasten the screw.



## Warranty Conditions

This instrument is guaranteed for a one-year limited warranty against material or production defects, in accordance with our general sales conditions. During the warranty period, Scarlet Tech reserves the right to decide either to repair or replace the product.

Should you need any reason to return the instrument for repair or replacement, take prior agreements with the local distributor from whom you bought it. Please use the original packaging for return. Do not forget to enclose a report describing the reasons for returning (detected fault). Any damage that occurred in transit due to non-original packaging will be charged to the customer.

Scarlet Tech's One-year Limited Warranty does NOT apply to:

- Accessories and batteries (not covered by warranty)
- Repairs made necessary by improper use or improper combination with incompatible accessories or equipment.
- Repairs made necessary by improper shipping material causing damages in transit.
- Repairs made necessary by previous attempts for the repair carried out by non-skilled or unauthorized personnel.
- Instruments for whatever reason modified by the customer himself without the explicit authorization of our Technical Dept.

The contents of this manual may not be reproduced in any form whatsoever without the authorization from Scarlet Tech.



Scarlet Tech Co., Ltd.  
© 2021 Scarlet Tech Co., Ltd. All rights reserved.  
4F-3, No. 347, HePing E Rd, 2nd Sec, DaAn District, Taipei City 106, Taiwan  
info@scarlet.com.tw  
www.scarlet-tech.com

version 210727