

*Kitagawa*

**GAS ASPIRATING PUMP**

**AP-20**

**INSTRUCTION  
MANUAL**



**KOMYO RIKAGAKU KOGYO K.K.**

## FOREWARD

Thank you for purchasing the Model AP-20 sampling pump. The Model AP-20 pump is designed specifically for use with Kitagawa detector tubes. This system with the available Kitagawa detector tubes can detect the presence of more than 300 airborne gases and vapours.

## FOR SAFE AND CORRECT USE

- ★ READ CAREFULLY BOTH THIS INSTRUCTION MANUAL AND THE INSTRUCTION SHEETS FOR THE INDIVIDUAL DETECTOR TUBES PRIOR TO USE OF THIS PRODUCT.
- ★ ENSURE THAT THIS INSTRUCTION MANUAL IS STORED IN A CONVENIENT LOCATION FOR EASY REFERENCE AT ALL TIMES.
- ★ IF YOU HAVE ANY QUESTIONS REGARDING THIS MANUAL, PLEASE CONTACT YOUR LOCAL DISTRIBUTOR, DEALER OR MANUFACTURER REPRESENTATIVE.

**This instruction manual uses the following symbols to indicate cautions and notes that promote the safe and correct use of this product.**

### Caution



This “Caution” symbol indicates that failure to observe this instruction can result in possible personal injury or damage to property.

### Note



This “Note” symbol indicates instruction or advice for the correct use of the product, to prevent problems with the products or its interpretation.

## Caution

- 1 With a detector tube inserted and the handle drawn back, the pump cylinder is under a high vacuum. If the handle lock is released under vacuum conditions, it will pull back suddenly. Holding the pump by the extended shaft can lead to injury. Always hold the pump by the cylinder, never by the shaft.
- 2 Broken glass tube tips can fall from the tip cutter or storage area when using the pump. To prevent glass contamination in restricted area (e.g., food processing plants) use the optional Model B-191 Tip cutter.
- 3 Normal use of detector tubes requires the handling of broken glass tubes. Safety glasses and protective gloves are recommended.
- 4 Detector tubes contain small amounts of chemical reagents, which may be toxic. Avoid skin and eye contact with the internal chemical reagents.

- 5 If the reagent is completely discoloured (i.e., the detector tube is over-ranged) after measuring a high concentration toxic gas (e.g., a process measurement), the possibility exists for harmful gas residue inside the cylinder. This gas will exhaust from the back of the cylinder when the handle is pulled out for the next pump stroke. Whenever the tube has fully discoloured, purge the air inside the cylinder by pulling and pushing the handle several times in a well-ventilated area.



## Note

- 1 If the proper detector tube for a particular application is not chosen, correct readings cannot be obtained. Choose detector tubes carefully using the tube selection guide and pay strict attention to chemical names and measuring ranges.
- 2 When gases other than the target gas are also suspected, refer to the tube instructions for information on interfering compounds and to the handbook for information on other relevant detector tubes.
- 3 A detector tube is designed for a single use; do not re-use detector tubes.
- 4 A detector tube should be used immediately after breaking the ends. Detector tubes exposed to the air for a long time after breaking the ends will give erroneous readings, and may not respond to the target gas at all.
- 5 Read the concentration immediately after completion of measurement. If not read immediately, the stain may lengthen or fade, which can lead to erroneous readings.
- 6 A leaking pump will produce low readings. Always check the pump for leakage before use in accordance with section "CHECKING PRIOR TO USE".
- 7 The temperature range for use of detector tubes in general is 0 to 40 degrees C. When using detector tubes at temperatures outside of the above range, refer to the section "MEASUREMENT AND OPTIONS UNDER SPECIAL CONDITIONS."
- 8 Do not drop or strike the pump. If the cylinder is dented, it will impede the handle operation and possibly cause leakage.
- 9 Should the pump be disassembled, hand tighten only on re-assembly. Over-tightening can damage threads
- 10 Clean the pump only with a dry paper towel. Do not use water or solvents.
- 11 Do not store the pump in the areas of high temperature or high humidity. Do not store with the handle extended, as the pump shaft is susceptible to bending under stress.
- 12 It is recommended that service repair be done only by authorized service centres. Any service or repair must be followed by a leak check prior to field use.
- 13 Note that the AP-20 pump is a vacuum pump only, and it cannot be used for specialized detector tubes that require sample entry by pressure (Oxygen, Hydrogen, Propane, etc.)
- 14 If using the following detector tubes, it is necessary to purchase and use the flow control orifice option.
  - Separation measurement of Acetylene · Ethylene
  - Phosphine SA type (No.121SA)
  - Phosphine SB type (No.121SB)

## ACCESSORIES CHECK LIST

Your kit should contain the following:

● ASPIRATING PUMP 1 pc.

● HAND STRAP 1 pc.

● GREEN



● RUBBER  
CONNECTOR

## AP-20 ASPIRATING PUMP COMPONENTS

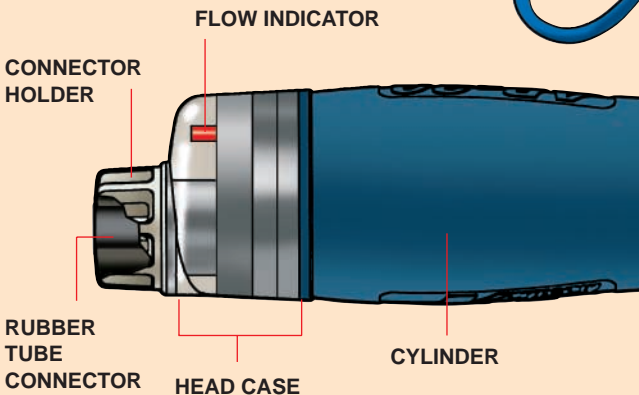

## DETECTOR TUBE TYPICAL COMPONENTS

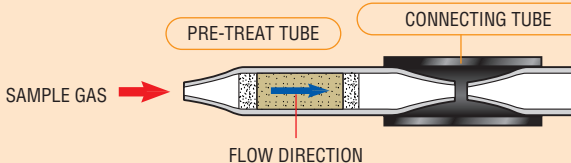
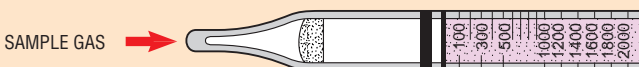

Following items. Verify that the accessories package is complete when unpacking.

BASE (10g) 1 pc.



TUBE  
CONNECTOR 2 pcs.



● INSTRUCTION MANUAL 1 copy



● CARRYING CASE 1 pc.

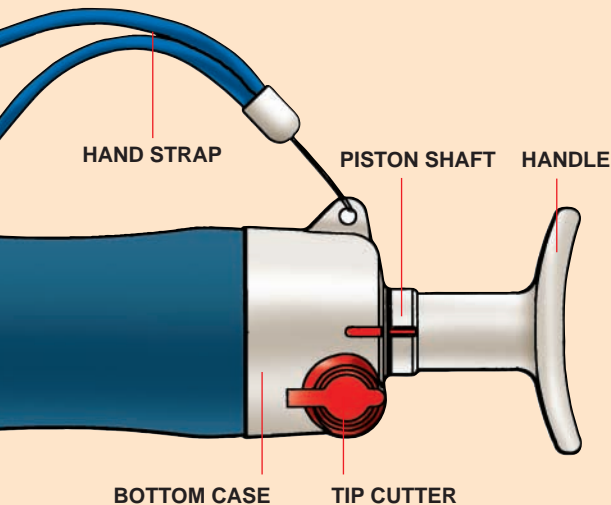

SAMPLE VOLUME



FLOW DIRECTION

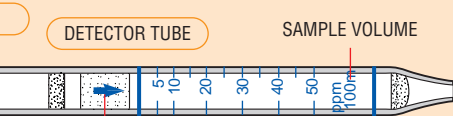

FLOW DIRECTION

## ▲ Note

A leaking aspirating pump may cause lower readings or no response at all. Always conduct the following check before use.

### CHECKING PRIOR TO USE (Leakage Test)



Insert a sealed, unbroken detector tube into the rubber tube connector. Align the red line on the bottom case and that of shaft, and pull the handle to full stroke locked position.



Wait one minute. Unlock the handle by turning it 1/4 turn (90 degrees), and check to see if the handle returns to the initial position. When the lock is released under full vacuum, the handle tends to snap back quickly. To prevent possible damage to the locking device allow the handle to return slowly by holding the cylinder and handle securely. If the handle returns completely to the original position, the performance is satisfactory.

### CAUTION!

Otherwise, refer to maintenance **HANDLE WILL TEND TO SNAP BACK** procedure in the pump instructions **INTO THE PUMP QUICKLY**. to correct the leak.

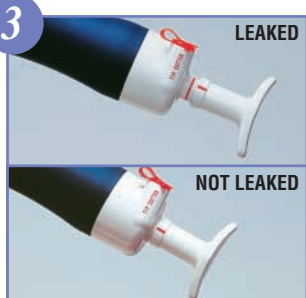

If the pump fails the leak test, the following are possible causes.

- A) A loose inlet connector holder.
- B) Cracks and deterioration of the rubber tube connector.
- C) Deterioration of the grease.

To correct a leaking pump, consult the "MAINTENANCE" section.

## MAINTENANCE

### ● Application of new vacuum grease

- 1 Pull the handle part way and turn the bottom case counterclockwise to remove it.
- 2 Pull the piston out from the cylinder.
- 3 Wipe off the old grease and dirt from the piston and inside the cylinder using a clean paper towel. Apply a thin coat of vacuum grease to the rubber gasket of the piston. When wiping off the old grease, be careful not to scratch the inside walls of the cylinder. Reassemble pump.

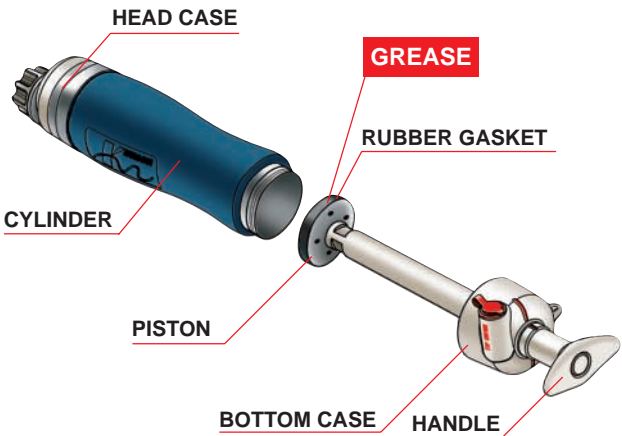

### ● Replacement of Rubber Tube Connector

If the rubber tube connector appears cracked or deteriorated, remove the connector holder and replace it with new one.

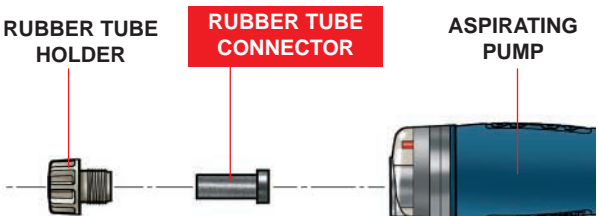

# OPERATING PROCEDURE



## Notes prior to use

- 1 The operating procedure varies from one detector tube to another. Before proceeding, read carefully the individual instruction sheets provided in each box.
- 2 Some detector tubes require temperature correction using tables provided in the instruction sheets. Be sure that the tube temperature has reached equilibrium with the sample area before drawing the sample.
- 3 When using detector tubes at pressure other than normal atmospheric pressure, correction of the reading is necessary. Refer to the section "MEASUREMENT AND OPTIONS UNDER SPECIAL CONDITIONS." To read the tube scale directly, it is necessary that the pressure of the sample gas is equal to that of aspirating pump.  
When sampling high-pressure systems, first collect the sample in a gas sampling bag (non-adsorbent material), then use the pump to draw the sample from the bag.

## MEASUREMENT

1

### Prepare Aspirating pump.

Check the pump for leaks in accordance with "CHECKING PRIOR TO USE". (Refer to page 5)

2

### Cut both ends of the gas detector tube.

Insert the tip of the gas detector tube into the tip cutter and scratch the tip of tube by rotating it for one revolution, then pull it toward you. (The glass tip can be thrown away by removing the tip cutter cap.)





**3****Connect the gas detector tube to the aspirating pump.**

The sample gas must be drawn through the gas detector tube in the correct direction. Insert the gas detector tube into the rubber tube connector with the tube's directional arrow pointing toward the pump.

**4****Pull the handle.**

Align the red line on the bottom case and that on the shaft and pull the pump handle to its full 100cc locking position. If the sample calls for a half stroke, pull out the pump handle until 50cc line appears, and shaft will be locked at 50cc.

**5****Draw the sample gas.**

Draw the sample gas for the specified time at the desired sampling point, and confirm with the flow indicator that the sample is completed. The sample time required for each detector tube is stated clearly in the instruction sheet.

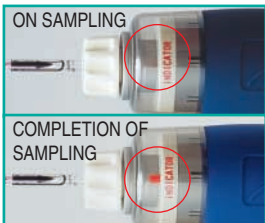
**6****Return the handle.**

When the sample is completed, turn the handle 1/4 turn (90 degrees) clockwise or counterclockwise to unlock the handle. Confirm that the handle remains extended. (If the handle returns part way, the sample is incomplete, and this will cause a low reading). Some detector tubes require extra pump strokes (i.e., more than 100cc of air). In this case, push back the handle and repeat the operation.

**7****Read the concentration.**

Remove the gas detector tube from the aspirating pump after the prescribed sample volume has been drawn. Read the concentration of gas at the maximum end of the stain against the printed scale on the detector tube. Some detector tubes require a temperature correction using a table or correction coefficient provided in the instructions.

## HOW TO READ THE GAS CONCENTRATION FROM GAS DETECTOR TUBE

[Direct reading type] Read the concentration of gas at the maximum end of the stain against the printed scale on the detector tube.

### 1. In case of faint discoloration

Read the concentration of gas at the maximum end of the stain.

DISCOLORED LAYER

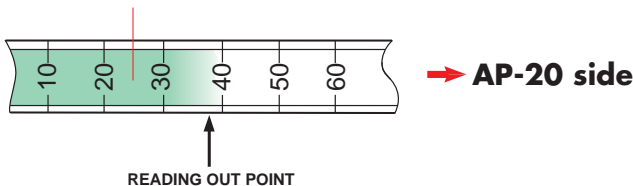

### 2. In case that the end of the stain is slanted.

Read out the numerical value at the middle of the oblique layer.

DISCOLORED LAYER

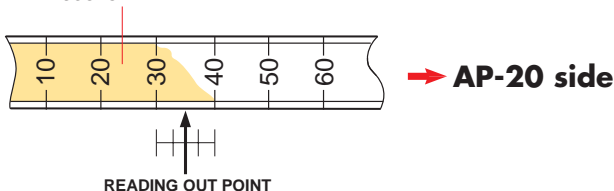

## [Concentration chart type]

Align the zero end of the detecting reagent (inlet side of the tube) with the **O - O** line on the concentration chart. Align the other end of the same layer (exit side or pump side of the tube) with the **L - L** line respectively. Read the gas concentration at the maximum end of the stain against the scale on the card. If the end is slanted, read at the middle point of the oblique stain.

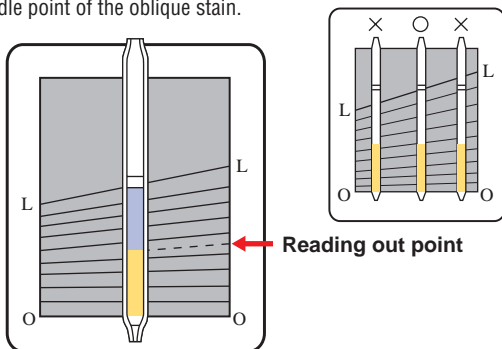

## TEMPERATURE CORRECTION PROCEDURE

The temperature of concern is that of the detector tube (usually the temperature of the sample gas).

### 1. IN CASE OF USE OF CORRECTION TABLE

[EX.1] When the tube reading is 550 ppm at 25 degrees C, the true concentration is found by interpolating between the concentrations listed for 20 and 30 degrees C. In this example, the corrected value is 560 ppm.

Temperature correction (At 20°C)					
Scale reading (ppm)	True concentration of carbon monoxide (ppm)				
	0°C	10°C	20°C	30°C	40°C
1,000	870	930	1,000	1,030	1,060
900	780	840	900	930	960
800	690	750	800	830	850
700	610	660	700	720	740
600	520	560	600	620	640
500	430	470	500	520	540
400	350	370	400	410	430
300	260	280	300	310	320
200	180	190	200	210	220
100	90	100	100	100	110

Scale readings °C	20°C	(25°C)	30°C
600	600	(610)	620
(550)	(550)	(560)	(570)
500	500	(510)	520
(450)	(450)	(457.5)	(465)
400	400	(405)	410

### 2. IN CASE OF USE OF CORRECTION COEFFICIENT

[EX.2] When the detector tube reading is 0.4 mg/l at 23 degrees C, the true concentration of water vapour is 0.36 mg/l by the following calculation.  $0.4 \text{ mg/l} \times 0.90 \doteq 0.36 \text{ mg/l}$

Temperature Correction Table

Temp.(°C)	0	1	2	3	4	5	6	7	8	9
0	1.85	1.81	1.77	1.72	1.68	1.63	1.59	1.54	1.49	1.45
10	1.40	1.36	1.31	1.27	1.23	1.19	1.15	1.11	1.07	1.03
20	1.00	0.96	0.93	0.90	0.87	0.84	0.81	0.78	0.76	0.73
30	0.71	0.68	0.66	0.64	0.62	0.60	0.58	0.56	0.55	0.53
40	0.51	—	—	—	—	—	—	—	—	—

(How to get readings from Temperature Correction Table)

When the temperature is 23, the value at the intersection of 20 and 3 is the correction Coefficient.

Temp.(°C)	0	1	2	3	4
0	1.85	1.81	1.77	1.72	1.68
10	1.40	1.36	1.31	1.27	1.23
20	1.00	0.96	0.93	0.90	0.87
30	0.71	0.68	0.66	0.64	0.62

# MEASUREMENT & OPTIONS UNDER

## 1) Remote measurement

A rubber extension hose (shown below) is used for remote detection of potentially harmful gases prior to entering a confined space such as a manhole or tank. The extension hose is placed between the detector tube and the aspirating pump to determine the gas concentration. The rubber extension hose is available in length of 5 or 10 meters.

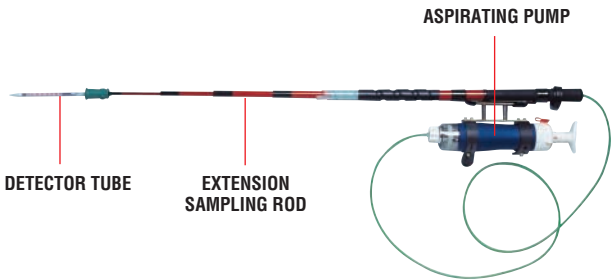
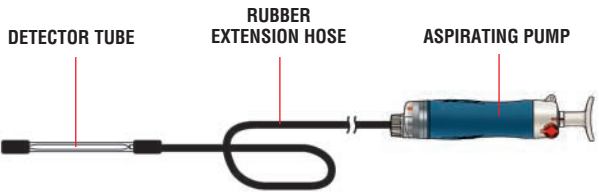

## 2) High temperature gas measurement

The allowable temperature range for detector tubes is generally, 0 to 40 degrees C. When measuring gases at temperatures outside of 0 to 40 degrees C, collect a volume of gas into a container, transport it to a moderate area (i.e., indoors) and allow it to equilibrate. Then draw the sample from the container. Care must be taken to choose a container of a material that is compatible with the target gas. (e.g., A glass syringe of 100cc or 200cc is a suitable container).

When flue gas or other high temperature gas is sampled, use the Hot Air Probe.



# THE SPECIAL CONDITIONS

## 3) High concentration gas measurement

High concentration gas exceeding the measuring range of the detector tube may be sampled as follows. Collect a volume of sample gas into a glass syringe and dilute with fresh air. (See photograph). The tube reading is then multiplied by the ratio of dilution to determine the actual concentration.

Example: Draw 50cc of sample gas into a 100cc syringe. Complete the syringe draw with fresh air. Take a reading and multiply by 2.

**GAS SYRINGE**



## 4) Measuring in an atmosphere under pressure or reduced pressure

If 100cc of gas is collected at a pressure that is two times atmospheric pressure, it is equivalent to 200cc of gas collected at normal atmospheric pressure. When measuring at pressures other than normal atmospheric pressure, a pressure correction is required. A true concentration can be obtained by the following equation. However, if the tube's concentration scale is nonlinear, a correction error is produced. Therefore it is recommended to collect the sample in a gas sampling bag, then measure it at normal atmospheric pressure for more accurate readings. When collecting gas in a high pressure atmosphere, please note that the bag can be ruptured by the expansion of the sample gas.

$$\text{Corrected value} = \frac{\text{Reading value on detector tube} \times 1013 \text{ [hPa]}}{\text{Atmospheric pressure in the measuring place [hPa]}}$$

## 5) Tip cutter Model B-191

**TIP CUTTER  
B-191**



When cutting the ends of detector tubes, splintering of glass tips can be avoided by using the Model B-191 Tip cutter. The container is transparent to let you see when it needs to be emptied.

## 6) Other options & spare parts

The following items are available as spare parts. (i.e., extra options)

- Rubber tube connector
- Grease
- Tip cutter
- Fixing screw

## ■ DISPOSAL OF DETECTOR TUBES

A detector tube contains a chemical reagent which reacts with the target gas. The chemical reagents used vary among different types of detector tubes, and may include substances regulated by laws for proper disposal. When discarding used detector tubes, dispose of them in accordance with local disposal regulations. For further information contact your local distributor or the manufacturer's head office or branches.



## DISTRIBUTOR'S NAME :



Distributed by: **Air-Met Scientific Pty Ltd**

**Air-Met Sales/Service**

P: 1800 000 744

F: 1800 000 774

E: sales@airmet.com.au

**Air-Met Rental**

P: 1300 137 067

E: hire@airmet.com.au

W: www.airmet.com.au

Adelaide | Brisbane | Gladstone | Mackay | Melbourne | Perth | Sydney



## **KOMYO RIKAGAKU KOGYO K.K.**

1-8-28 Shimonoge, Takatsu-ku, Kawasaki-City,  
Kanagawa 213-0006, Japan

Tel : +81 (0) 44-833-8911/Fax : +81 (0) 44-833-2672

URL: <http://www.komyokk.co.jp/english/> E-mail: qa@komyokk.co.jp

※ Specifications and external appearance are subject to change for the reason of improvement without any prior notice.